



Installation Guide and Technical Specification

RAB™ Board

COMMERCIAL

Australia May 2020

Make sure your information is up to date.

When specifying or installing James Hardie™ products, ensure that you have the current technical information and guides. If in doubt, or you need more information, visit www.jameshardie.com.au or Ask James Hardie™ on 13 11 03.

CONTENTS

1	INTRODUCTION	2
2	SAFE WORKING PRACTICES	3
	Working Instructions	3
	Storage and handling	3
3	PRODUCT PERFORMANCE AND INFORMATION	4
	Sizes and profiles	4
	Properties	4
	Thermal performance	4
	Energy Efficiency	4
	Reflectivity	4
	Acoustic Performance	4
	Accessories	4
3	DESIGN CONSIDERATIONS	5
	Fire	5
	Water	5
	Condensation (vapour permeability, climate zones)	5
	Weatherproofing	5
	Rainscreen (Water barrier)	5
	Wind	5
	Framing	5
	Bracing (structure/wind/seismic)	5
5	INSTALLATION	7
	Overview (3d image)	7
	Preparation	7
	Fixings (Fasteners)	7
	Tape	7
	Window and doors sealing	7
	Service Penetrations	7
6	DETAILS	8
	Fastener and Fixing	8
	Slab junction (flushed, overhang)	8
	Joints	9
	Corners	10
	Windows	11
	Parapet and Penetrations	12

1 INTRODUCTION

Finding a balance between water and condensation management, air-tightness and non-combustibility can be challenging - particularly when it comes to designing taller and more complex facades which are subject to higher wind pressures from more extreme weather events.

This is why a solution that offers protection and peace of mind is the only way to overcome poor building performance and reduced comfort levels for occupants.

Introducing RAB™ board, the rigid air barrier by James Hardie.

Designed to meet the building industry's changing requirements for high-performance weather barriers, this unique green panel is sealed with James Hardie's innovative CoreShield™ penetrating sealer technology, keeping water, air and wind out, while allowing moisture vapour to easily escape - enabling the framing cavity to drain and dry.

Installed beneath external cladding or rainscreens, RAB™ board delivers superior water resistance, long-term durability and strength - and is also suitable for use in non-combustible construction.

The result of James Hardie's extensive innovation and research into durable and resilient façade design, RAB™ board provides a fully-certified solution that offers superior defence against wind and moisture.

The RAB™ board supplied by James Hardie is warranted for a period of 10 years.

Please refer to the terms and conditions stated in the warranty document available at JamesHardie.com.au.

If you are a specifier...

Or other responsible party for a project, ensure the information in these specifications is appropriate for the application you are planning and that you undertake specific design and detailing for areas which fall outside the scope of these specifications.

If you are an installer...

Ensure that you follow the design, moisture management and associated details and material selection provided by the designer and the RAB™ board Installation Guide.

IMPORTANT NOTES

1. Failure to install, finish or maintain this product in accordance with applicable building codes, regulations, standards and James Hardie's written application instructions may lead to personal injury, affect system performance, violate local building codes, and void James Hardie's product warranty.
2. All warranties, conditions, liabilities (direct, indirect or consequential) and obligations whether arising in contract, tort or otherwise other than those specified in James Hardie's product warranty are excluded to the fullest extent allowed by law. For James Hardie's product warranty information and disclaimers about the information in this guide, visit www.jameshardie.com.au.

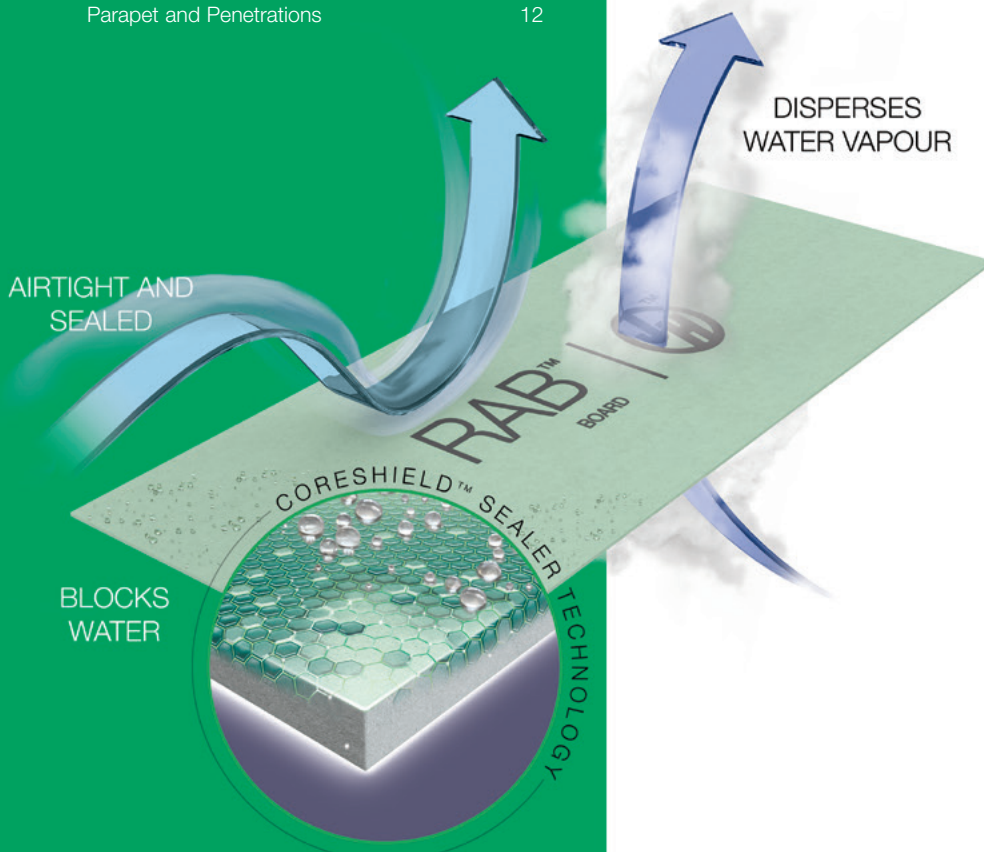

MADE IN AUSTRALIA

2 SAFE WORKING PRACTICES

WARNING - DO NOT BREATHE DUST AND CUT ONLY IN WELL VENTILATED AREA

James Hardie products contain sand, a source of respirable crystalline silica. **May cause cancer if dust from product is inhaled. Causes damage to lungs and respiratory system through prolonged or repeated inhalation of dust from product.**

Intact fibre cement products are not expected to result in any adverse toxic effects. The hazard associated with fibre cement arises from the respirable crystalline silica present in dust generated by activities such as cutting, rebating, drilling, routing, sawing, crushing, or otherwise abrading fibre cement, and when cleaning up, disposing of or moving dust. When doing any of these activities in a manner that generates dust, follow James Hardie instructions and best practices to reduce or limit the release of dust, warn others in the area and consider rotating personnel across the cutting task to further limit respirable silica exposure. If using a dust mask or respirator, use an AS/NZS1716 P1 filter and refer to Australian/New Zealand Standard 1715:2009 Selection, Use and Maintenance of Respiratory Protective Equipment for more extensive guidance and more options for selecting respirators for workplaces. For further information, refer to our installation instructions and Safety Data Sheets available at www.jameshardie.com.au. **FAILURE TO ADHERE TO OUR WARNINGS, SAFETY DATA SHEETS, AND INSTALLATION INSTRUCTIONS MAY LEAD TO SERIOUS PERSONAL INJURY OR DEATH.**

JAMES HARDIE RECOMMENDED SAFE WORKING PRACTICES

CUTTING OUTDOORS

1. Position cutting station so wind will blow dust away from the user or others in working area.
2. Warn others in the area to avoid dust
3. Consider rotating personnel across cutting tasks to further limit respirable silica exposures.
4. Use one of the following methods based on the required cutting rate:
 - Best** ■ Villaboard™ knife ■ Hand guillotine ■ Fibreshear
 - Better** ■ Position the cutting station in a well-ventilated area. Use a dust reducing circular saw equipped with HardieBlade™ Saw Blade or comparable fibre cement blade and well maintained M-class vacuum or higher with appropriate filter for capturing fine (respirable) dust. Wear a properly-fitted, approved dust mask or respirator (minimum P1).

CUTTING INDOORS

- Cut only using Villaboard™ knife, hand guillotine or fibreshears (manual, electric or pneumatic).
- Position cutting station in a well-ventilated area.

DRILLING / OTHER MACHINING

When drilling or machining you should always wear a P1 dust mask and warn others in the immediate area.

IMPORTANT NOTES

1. For maximum protection (lowest respirable dust production) James Hardie recommends always using best practice cutting methods where feasible.
2. NEVER use a power saw indoors or in a poorly ventilated area.
3. ALWAYS use a dust reducing circular saw equipped with a sawblade specifically designed to minimise dust creation when cutting fibrecement - preferably a sawblade that carries the HardieBlade™ logo or one with at least equivalent performance - connected to a M class or higher vacuum.
4. NEVER dry sweep - Use wet suppression, or an M class vacuum or higher with appropriate filter.
5. NEVER use grinders.
6. ALWAYS follow tool manufacturers' safety recommendations.
7. ALWAYS wear a properly fitted, approved dusk mask, P1 or higher.

DUST MASKS AND RESPIRATORS

As a minimum, an AS/NZS1716 P1 respirator must be used when doing any activity that may create dust. For more extensive guidance and options for selecting respirators for workplaces please refer to Australian/New Zealand Standard 1715:2009 "Selection, Use and Maintenance of Respiratory Protective Equipment". P1 respirators should be used in conjunction with the above cutting practices to minimise dust exposure. For further information, refer to Safety Data Sheet (SDS) available at www.jameshardie.com.au. If concern still exists about exposure levels or you do not comply with the above practices, you should always consult a qualified industrial hygienist or contact James Hardie for further information.

2.1 WORKING INSTRUCTIONS

Refer to recommended safe working practices before starting any cutting or machining of product.

Villaboard™ Knife - Score and snap

Score and snap is a fast and efficient method of cutting James Hardie™ building products using James Hardie's Villaboard™ knife. Preferably score on the face side of the product. Score against a straight edge and repeat the action to obtain adequate depth for clean break – normally one third of sheet thickness. Snap upwards to achieve break. Smooth any rough edges with a rasp.

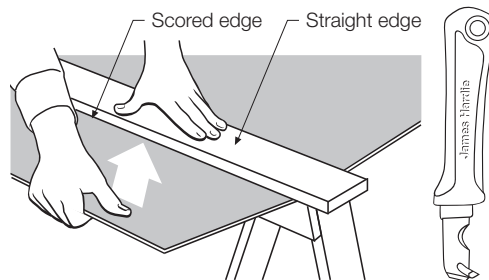

HardieBlade™ Saw Blade

The HardieBlade™ Saw Blade used with a dust-reducing saw is ideal for fast, clean cutting of James Hardie™ fibre cement products. When sawing, clamp a straight-edge to the sheet as a guide and run the saw base plate along the straight edge when making the cut.

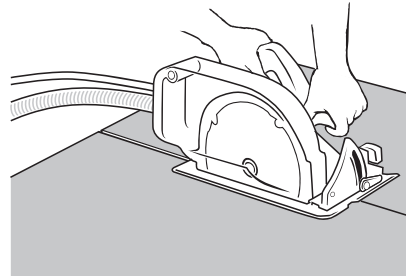

2.2 STORAGE AND HANDLING

To avoid damage, all James Hardie™ building products should be stored with edges and corners of the product protected from chipping. James Hardie™ building products must be installed in a dry state and protected from weather during transport and storage. The product must be laid flat under cover on a smooth level surface clear of the ground to avoid exposure to water, moisture, etc.

3 PRODUCT PERFORMANCE AND INFORMATION

3.1 – SIZES AND PROFILES

RAB™ BOARD					
PRODUCT	DESCRIPTION	SHEET SIZES			
	Thickness: 6mm Mass: 8.7kg/m ²	Vertical install over 600, 400 and 300mm framing			
		Product Codes	Width (mm)	Length (mm)	Weight (kg)
		405127	1200	2700	26.0
		405126	1200	3000	29.0
		Vertical install over 450mm framing			
		Product Codes	Width (mm)	Length (mm)	Weight (kg)
405128	1350	2700	29.2		
405117	1350	3000	32.6		



3.2 – PHYSICAL PROPERTIES

RAB™ BOARD		
PHYSICAL PROPERTY		STANDARD
Air Barrier	<0.6cm ² /cm ² Sec	ISO 9237-1995
Combustibility	Suitable where non-combustible materials are required	Deemed to comply with NCC Vol 1 C1.9(e)(iv) and Vol 2 3.7.1.1
Early Fire Hazard Properties	(Lower Values Are Better)	AS/NZS 1530.3
- Ignitability Index	0	
- Spread of Flame Index	0	
- Heat Evolved Index	0	
- Smoke Developed Index	0-1	
Vapour Control category	Vapour Permeable - Class 3 (1.1 MN s/g)	AS/NZS 4200.1 (ASTM E96 B)
Water Barrier	Passes	AS/NZS 4201.4
Watertightness	Passes	AS/NZS 2908.2
Thermal Conductivity	0.23W/m K	ASTM C 518
Material R-Value	0.026m ² K/W	ASTM C 518
Minimum Bending Strength Category	>7.0Mpa	AS/NZS 2908.2
Type	3	
	A	

3.3 – ACCESSORIES

FASTENERS

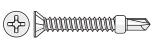
Fasteners must have the appropriate level of durability required for the intended project. This is of particular importance in coastal areas, areas subject to salt spray and other corrosive environments. Fasteners must be fully compatible with all other materials that they are in contact with to ensure the durability and integrity of the assembly. Contact fastener manufacturers for more information.

	HardieDrive™ Screw 25mm A Class 3 self-tapping wing tipped screw for fastening 0.5mm to 1.6mm BMT light gauges steel frames. 1000 per box. Part No. 305979		HardieDrive™ Collated Screw 25mm A Class 3 self-tapping wing tipped screw for fastening 0.5mm to 1.6mm BMT light gauges steel frames. Suitable for use in most auto feed screw guns. Part No. 305980
	Fibre Cement Nail 2.8 x 30mm fibre-cement nail for timber frames		

ACCESSORIES

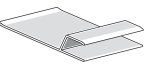
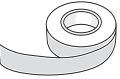
ACCESSORIES	DESCRIPTION
	James Hardie™ PVC Flashing Mould for 6mm thick sheets. 3000mm long A PVC extrusion for multicourse fixing of 6mm thick sheets. Part No. 305552
	James Hardie™ 9mm Aluminium Flashing for 6mm thick sheets. 3000mm long A ready to to paint aluminium horizontal flashing for horizontal control joints. Part No. 305613
	Sealing Tape Tape used to seal vertical joints and flash around window, door and pipe penetrations. Recommended Tapes: <ul style="list-style-type: none"> - 3M All Weather Flashing 8067 (min 75mm wide for joints and windows) - Pro Clima TESCON EXTORA (min 60mm wide for joints) - Pro Clima TESCON EXTOSEAL (for windows) Please contact James Hardie for alternative tape specifications.

TOOLS

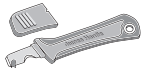
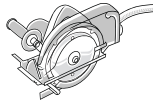
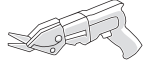
ACCESSORIES	DESCRIPTION
	Villaboard™ Knife A score and snap knife designed to efficiently cut through fibre cement sheets. Part No. 305915
	Dust reducing saw with a HardieBlade™ saw blade and M class vacuum or higher extraction Used to cut James Hardie™ fibre cement and also can be used to cut enrolled HardieWrap™ weather barrier roll on site to a shorter roll length. 1 per pack. Part No. 305571
	James Hardie™ Fibreshear Electric tool for cutting fibre cement sheets. Part No. 305653

4 DESIGN CONSIDERATIONS

4.1 TOLERANCES

Ensure frame is square and work from a central datum line. Frames must be straight and true to provide a flush face to receive the sheeting. A suggested maximum tolerance up to 4mm in any 3000mm length of frame will give best results. RAB™ board will not straighten excessively warped or distorted frames and any warping may still be visible after the cladding is applied.

4.2 WATER MANAGEMENT

4.2.1 Water Control Classification

RAB™ board is classified as a Water Barrier in accordance with the equivalent water barrier classifications within AS/NZS 4200.1.

James Hardie RAB™ board is factory sealed on the front face with a hydrophobic penetrating sealer, CoreShield™ Technology which repels moisture rapidly and resists moisture penetration, therefore no additional water barrier is required to provide a continuous seal when the jointing system is correctly applied.

4.2.2 Condensation Management

RAB™ board is classified as Vapour Permeable when assessed using the Vapour Permeance classifications of AS/NZS 4200.1 based on testing in accordance with ASTM E96, and appraisal from BRANZ.

James Hardie recommends using a vapour permeable membrane in accordance with AS 4200.1:2017 and AS 4200.2:2017 such as RAB™ board or equivalent in all external cladding in climate zones 2-8 (marked as green).

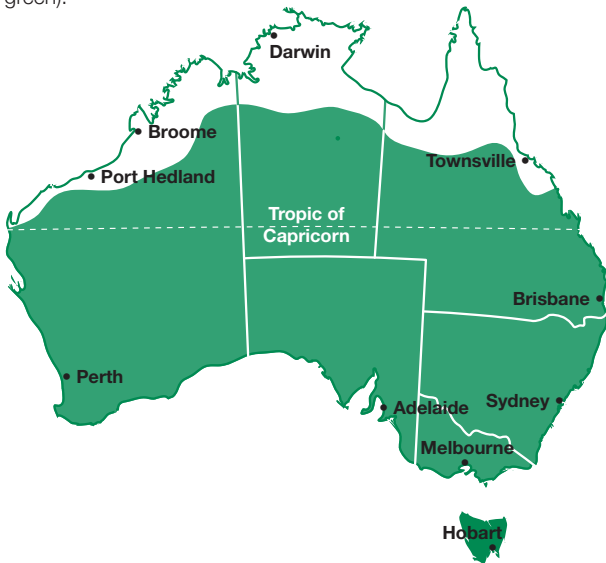

For Climate Zone 1, RAB Board must have a suitable vapour barrier membrane installed over its surface to prevent condensation issues. Call James Hardie for more information.

4.3 STRUCTURAL DESIGN PRESSURES

4.3.1 Design Wind Pressure & Structural Framing

RAB™ board is suitable to withstand high wind pressures in conjunction with cladding and commercial façade systems. In these applications, RAB™ board must be fixed directly to appropriate steel or timber framing members in accordance with the instructions within this installation guide.

Where Design Wind Pressure exceeds 7.0kPa please contact James Hardie for more information.

Steel Framing members must have the appropriate level of durability required to prevent corrosion and BMT between 0.55mm to 1.66mm. The framing used must comply with the relevant building regulations and standards. It is the installer's responsibility to assess the suitability of the substructure.

TABLE 1 - ULTIMATE DESIGN WIND PRESSURE - STUD & FASTENER SPACING

Ultimate Design Wind Pressure – ULS (kPa)	Stud Spacing (mm)	Fastener Spacing (mm)		
		A	B	C*
1.0	600	Not required unless for bracing (refer to Table 2 ULS Bracing Capacity ~Note 4)	300	300
1.5	600		300	300
2.0	450		300	300
2.5	450		275	275
3.0	450		225	225
3.5	400		225	225
4.0	400		200	200
4.5	300		225	225
5.0	300		200	200
5.5	300		200	200
6.0	300	175	175	
6.5	300	150	150	
7.0	300	150	150	

- The 6mm RAB™ board is designed to be supported/fixed onto its own stud-framing system, for example a minimum of 0.55mm gauge steel framing, independent of the Exotec façade top-hat framing system. Contact James Hardie if you wish to use timber framing for the RAB™ board layer.
- RAB board has been designed for a lower wind speed on the basis that it is a temporary structure and must therefore be covered by a suitable cladding or facade system within 6 months (180 days).
- The builder is permitted to cut the RAB™ boards to make up shorter segments of wall, for example between openings, however boards must span over at least three studs so that a minimum two-span continuous arrangement is maintained. Do not fix boards in a single span layout.
- If structural bracing capacity is required from the RAB system, select the appropriate capacity for 6mm JHFC from the design tables in the James Hardie Structural Bracing Application Guide based on the stud spacing and whether it will be single- or double-sided, noting that a 6mm JHFC internal lining would qualify for the latter. The fastener spacing shall be the lesser of the figures for RAB™ board in the table above and the specified pattern for 6mm JHFC from the bracing manual. Refer to Table 2.

4.3.2 Structural Bracing

When RAB™ board is to be used as structural bracing it must be fixed along the top and bottom edge. The spacing between the fixings depends on the required bracing capacity. Do not affix RAB™ board to a deflection head track.

For more information and specification of fastener spacings, the designer must refer to James Hardie's Structural Bracing Application Guide.

TABLE 2 - BRACING CAPACITY

Wall Configuration	Bracing Capacity (kN/m)*			Maximum Stud Spacing (mm)	Fastener Spacing A/B/C (mm)
	Timber stud	0.55 BMT Steel Stud	0.75 BMT Steel Stud		
RAB™ Board affixed to external side of stud – assuming standard plasterboard or no internal lining~	-	3.0	3.3	600	200/200/200
	2.8	3.0	3.3	600	150/150/200
	3.3	5.4	6.0	600	100/100/150
	3.3	6.0	6.2	450	100/100/150
	6.6	6.0	6.2	450	50/100/150

* Bracing capacity will be reduced where the wall is higher than 2.7metres. Walls that are 3m will require a reduction factor of 0.9. Bracing capacity will be reduced for panels that are cut and installed less than 900mm width. Refer to James Hardie™ Structural Bracing Design Guide Tables 2 and 3 for more information.

~ For more bracing information and other wall configuration, including double lined walls, refer to James Hardie™ Structural Bracing Design Guide or call James Hardie on 13 11 03

4.3.3 Fastener Selection

Select the fastener suitable for the required framing from the appropriate product section depending on the type of framing, either timber or steel.

Note: because RAB™ board is sealed with the CoreShield™ sealer technology, the fasteners are not required to be patched, sealed or otherwise treated.

NOTE: Fasteners must NOT be overdriven. Fasteners should be screwed as close as possible to the stud corners to avoid deflection of the stud flange.

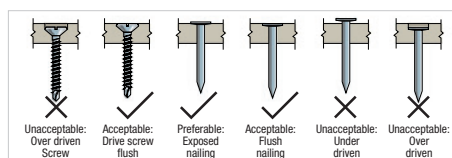

4.4 FIRE SAFETY

4.4.1 Non-Combustibility

RAB™ board is a pre-sealed fibre cement sheet manufactured to comply with AS/NZS 2908.2:2000 Cellulose-cement products - Flat Sheets (ISO 8336 Fibre-cement flat sheets) and is therefore suitable where non-combustible materials are required in accordance with Deemed-to-Satisfy Provisions of the NCC Volume One Amendment 1. (Refer to Section C, Part C1, C1.9 (e)).

The nominated accessories, including the tapes and jointers are have been individually assessed in accordance with the exemptions and concessions within the Fire Safety provisions of the NCC - contact James Hardie for more information and details (refer to advisory note IGNS-8057). The project specifier or certifier is responsible for ensuring that the materials, accessories and components are suitable and compliant for the specific building.

4.4.2 Fire Performance

James Hardie building products have been tested by CSIRO in accordance with AS/NZS 3837 and are classified as conforming to Group 1 material (highest and best result possible), with an average specific extinction area far lower than the permissible 250m²/kg, as referenced in Specification C1.10a of the National Construction Code (NCC).

4.4.3 Fire Resistance Level (FRL)

Both one and two way fire rated wall systems are available with the RAB™ board when used as part of an external wall system. This will depend on the wall configuration and internal materials used. For more information refer to the James Hardie Fire and Acoustic Rated Walls Application Guide.

When RAB™ board is installed in conjunction with fire rated plasterboard, the fire rated plasterboard should be installed direct to the stud framing system, and RAB™ board installed over the top. Increase the length of the specified screw by the thickness of the plasterboard to ensure adequate embedment.

4.5 ENERGY EFFICIENCY

4.5.1 Airtightness

RAB™ board is classified as an Air Barrier in accordance with ISO 9237 - 1995. RAB™ Board can be used as part of an airtight assembly to satisfy the requirements of JP1(e) NCC 2019 Vol 1. When installed as part of an airtight assembly, with all joints and junctions adequately sealed, RAB™ Board can reduce leakage of internal air to achieve occupant comfort air-change rates.

James Hardie recommends utilising the NCC specified blower door test in accordance with NCC Vol 1 JV4 (Method 1 of AS/NZS ISO 9972), during and after construction to validate the airtightness of the envelope, allowing the designer to adjust by incorporating more ventilation or improve the building seal. For more information regarding the expected airtightness improvement and other design considerations refer to

BRANZ Rigid sheathing and airtightness in New Zealand, SR299, or call James Hardie on 13 11 03.

4.5.2 Thermal Efficiency

Section J of the NCC 2019 Vol 1 requires the structure to have certain degree of thermal performance to ensure a limited energy usage. Table 3 presents different system variations and their respective R-Value (Assessed based on AS4859.2:2018 Thermal Insulation Materials for Building. Part 2: Design), required as input data in the different compliance pathways described in the NCC. Each calculation result is subject to any specific table requirements and notes - If a construction differs from the described systems, the thermal resistance may be different, please contact James Hardie for further information.

4.6 GROUND CLEARANCE

Install RAB™ board with a minimum 150mm clearance to the earth on the exterior of the building or in accordance with local building codes if greater than 150mm is required. Maintain a minimum 50mm clearance between RAB™ board and roofs, decks, paths, steps and driveways. 30mm clearance is required for undercover balconies.

Adjacent finished grade must slope away from the building in accordance with local building codes, typically a minimum slope of 50mm minimum over the first metre.

Do not install RAB™ board such that it may remain in contact with standing water.

NOTE: Greater clearance may be required in order to comply with termite protection provisions, see below for more information

4.6.1 Termite Protection

The National Construction Code (NCC) specifies the requirements for termite barriers. Where the exposed slab edge is used as part of the termite barrier system, a minimum of 75mm of the exposed slab edge must be visible to permit ready detection of termite entry.

4.7 TEMPORARY WEATHER PROTECTION

Installation of internal lining can be started after James Hardie rigid air barriers have been installed on the exterior of the building envelope. In order to achieve this, all sheet joints and penetrations must be sealed and the roof, soffit lining, windows/doors (including head flashings and airseals) must have been installed to ensure the building is weathertight before starting the installation of internal linings.

The insulation, electrical cables, plumbing and any other services required in external walls must be installed and inspected by the building consent authority before starting the installation of internal linings. The internal lining and services must be installed in accordance with their manufacturer's product literature and comply with the NCC requirements.

The claddings must be installed within 180 days after the installation of James Hardie rigid air barriers.

TABLE 3 - TYPICAL FACADE SYSTEMS INCORPORATING JAMES HARDIE RAB™ BOARD

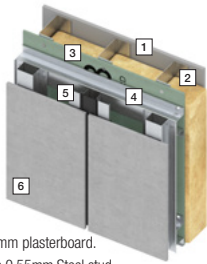
	Stud Spacing	Stud Size	Batt Size	James Hardie and intermediate top hats fixed to structural noggins						James Hardie and intermediate top hats fixed to 15mm horizontal top hats						
				Thermal R-Value Summer ³	Thermal R-Value Winter ³	Thermal U-Value Summer	Thermal U-Value Winter	Acoustic (Rw) ⁴	Wall thickness (mm)	Thermal R-Value Summer ³	Thermal R-Value Winter ³	Thermal U-Value Summer	Thermal U-Value Winter	Acoustic (Rw) ⁴	Wall thickness (mm)	
				1 10mm plasterboard. 2 Min 0.55mm Steel stud with fibreglass insulation (64, 92, or 150mm). Noggin spacing at 900mm centers. 3 6mm RAB™ Board. If an FRL is required fire resistant plasterboard must be installed to stud underneath the RAB™ Board in accordance with James Hardie Fire and Acoustic Rated Walls Guide. 4 15mm horizontal top hats spaced at 900mm centers. 5 35mm James Hardie™ Top hat fixing system. 6 ExoTec™ Facade Panels.	600	64mm	R1.5	1.33	1.43	0.75	0.70			124	1.54	1.65
	450			1.27	1.36	0.79	0.74	45			1.46	1.56	0.69	0.64	47	139
	300			1.17	1.25	0.86	0.80				1.32	1.41	0.76	0.71		
	600			1.74	1.86	0.57	0.54				2.12	2.27	0.47	0.44		
	450	92mm	R2.5	1.64	1.74	0.61	0.57	47	152		1.96	2.09	0.51	0.49	50	167
	300			1.46	1.55	0.68	0.64				1.71	1.82	0.59	0.55		
	600			1.85	1.97	0.54	0.51				2.19	2.36	0.46	0.42		
	450	150mm	R2.5	1.75	1.86	0.57	0.54	50	210		2.05	2.20	0.49	0.46	54	225
	300			1.58	1.68	0.63	0.60				1.81	1.94	0.55	0.52		

Notes:

- The above estimates the resulting (overall) Total R for the whole wall surface (excluding glazing) from the parallel heat paths. Insulation R adjusted for its mean temperatures for 18°C indoor and 12 °C outdoor winter, or 24 °C indoor and 36 °C outdoor summer, Australia. Indoor and outdoor air temperatures per AS/NZS4859.2:2018 Clause 5.1. For full report access, please contact James Hardie.
- Steel frame systems have been estimated with a nominal Base Metal Thickness (BMT) of 0.75mm. For frames with BMT of 0.55mm or lower the overall Total R-Value may be increased by 0.1.
- Overall resulting R Value per AS/NZS 4859.2:2018 Clause 4.3. Total transmittance (U) calculated by U=1/R. Total R & U values include indoor and outdoor air film.
- Refer to James Hardie™ Fire & Acoustic Rated Wall Application Guide or call James Hardie on 13 11 03 for increased fire and acoustic performance. The presented Rw is an acoustic estimate only and was produced using a software tool called INSUL. Comparisons with test data show that it is generally within 3 STC points for most constructions.
- If 12mm ExoTec™ cladding (R0.020) is used instead of 9mm ExoTec™ cladding (R0.015), all Total R results will increase by 0.005.
- 10mm plasterboard has R0.059, so for Villaboard™ (R0.013) indoor lining, subtract 0.046 from the above Total R results.
- RAB™ Board is assumed to be non-reflective on both sides, if the cavity side was reflective, all total R values results would increase by about 0.5.

5 INSTALLATION

5.1 WALL SYSTEM OVERVIEW



FIGURE 1 OVERVIEW OF THE WALL SYSTEM

5.2 RAB™ BOARD - 3 STEP INSTALL PROCESS



RAB™ board must be installed vertically direct to stud frame with the green side facing outwards.



Affix to frame with HardieDrive™ screws leaving a 2mm gap between each sheet and 100mm clearance from the board top and bottom edges. Fasten to the frame at fixing centres in Table 1.

Ensure that horizontal joints are appropriately jointed using the h jointer.



Tape all joints, from the bottom up: first the bottom edge, second the vertical joints and then the top edge.

Apply pressure to the tape in accordance with manufacturer's instructions to ensure adhesion. Tape must be overlapped by 30mm at all intersections.

DO NOT allow air bubbles or gaps paying particularly close attention to sealing corners and junctions.

6 CONSTRUCTION DETAILS

Fastener and Fixing Details

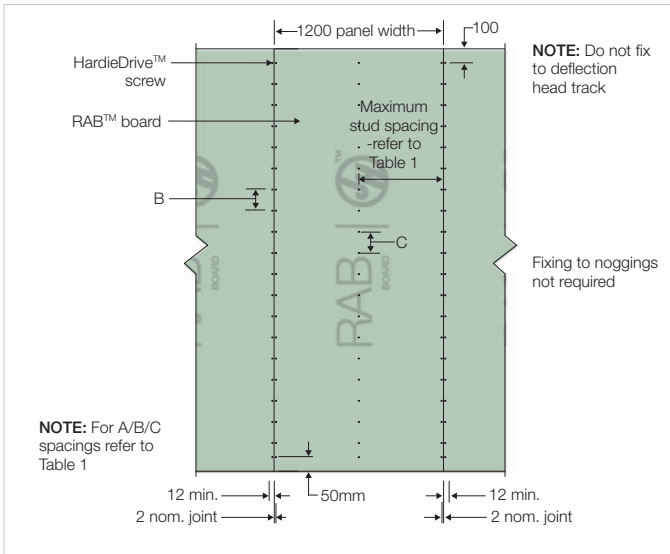

FIGURE 2 FIXING LAYOUT (NO BRACING CAPACITY)

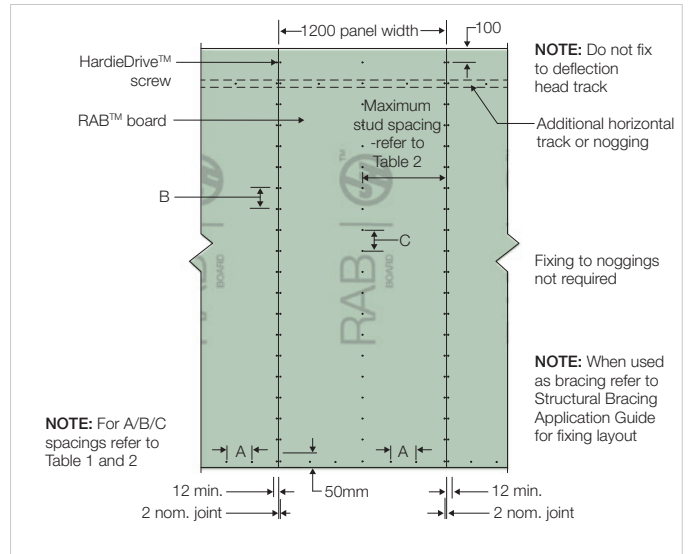

FIGURE 3 FIXING LAYOUT FOR STRUCTURAL BRACING

Horizontal Slab Junction Details

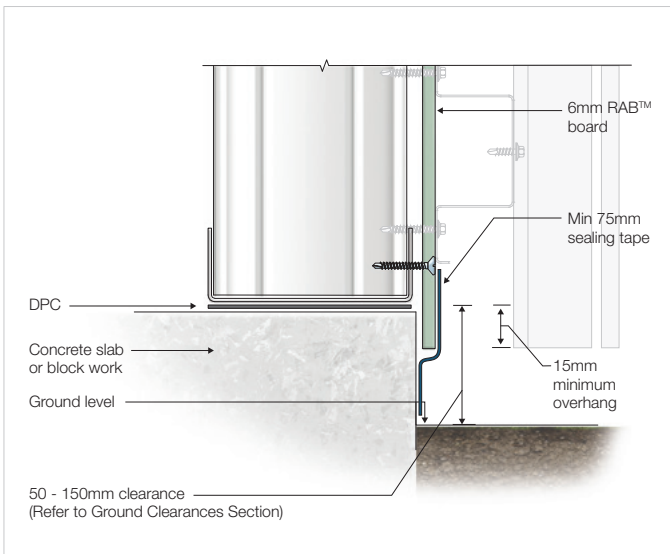

FIGURE 4 BASE DETAIL GROUND FLOOR

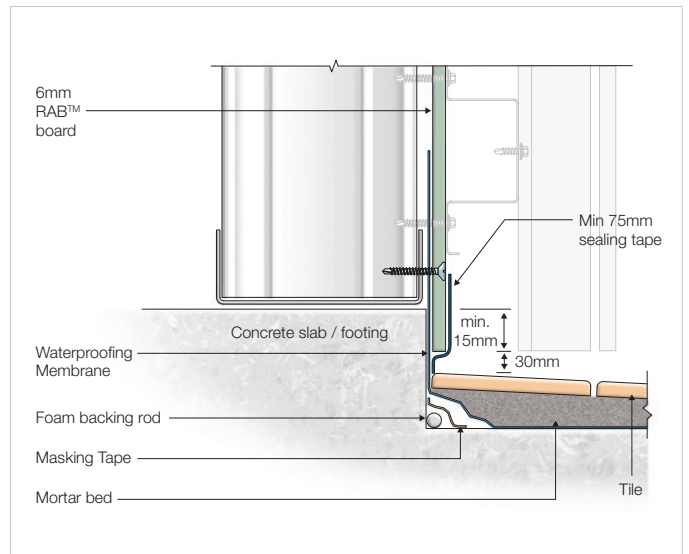

FIGURE 5 BASE DETAIL BALCONY

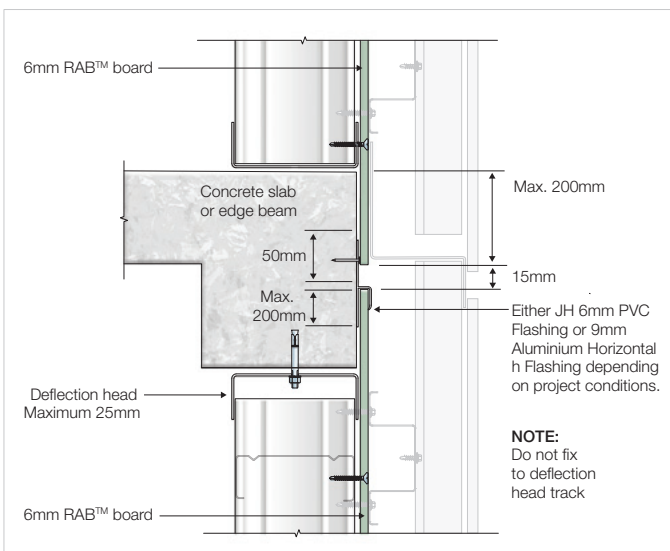

FIGURE 6 HORIZONTAL SLAB JUNCTION (CONTINUOUS)

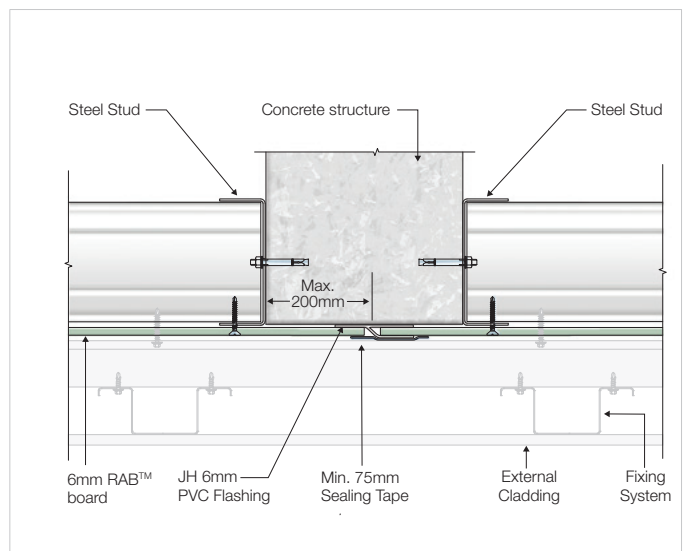

FIGURE 7 VERTICAL COLUMN JUNCTION (CONTINUOUS)

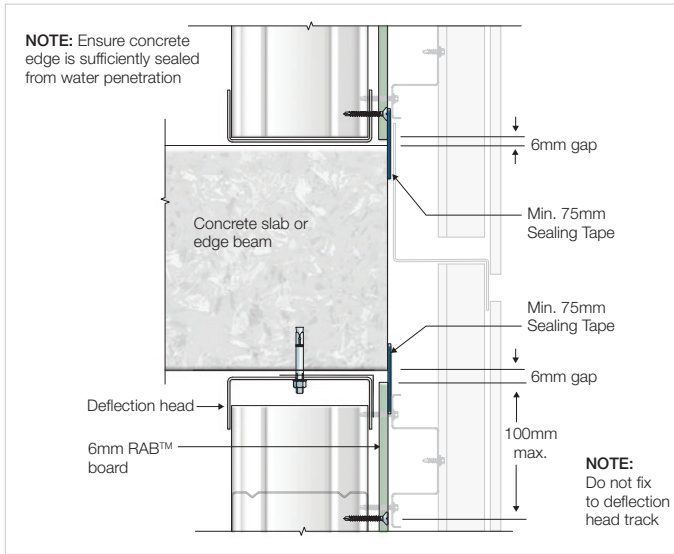

FIGURE 8 HORIZONTAL SLAB JUNCTION (BUTTED)

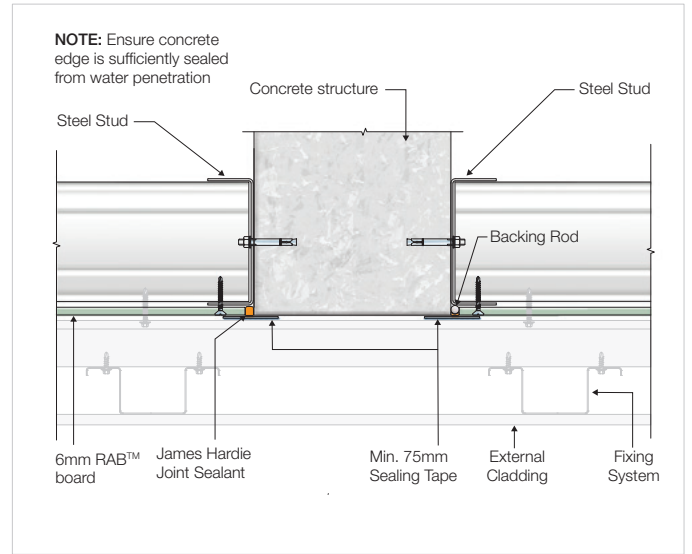

FIGURE 9 VERTICAL COLUMN JUNCTION (BUTTED)

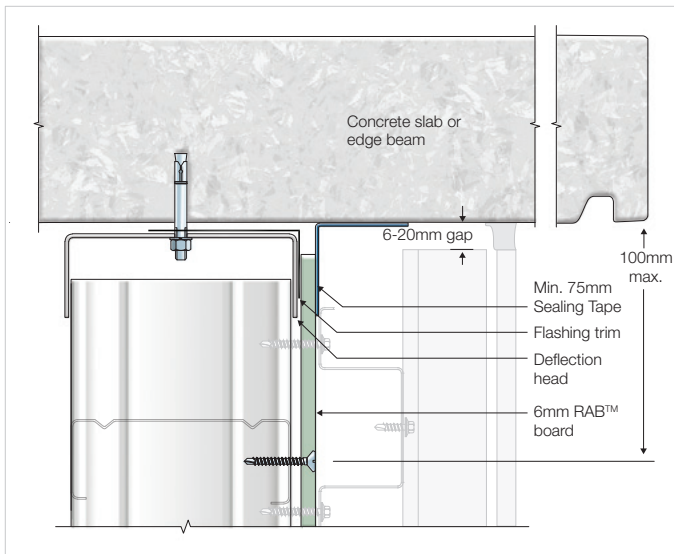

FIGURE 10 UNDER SLAB JUNCTION

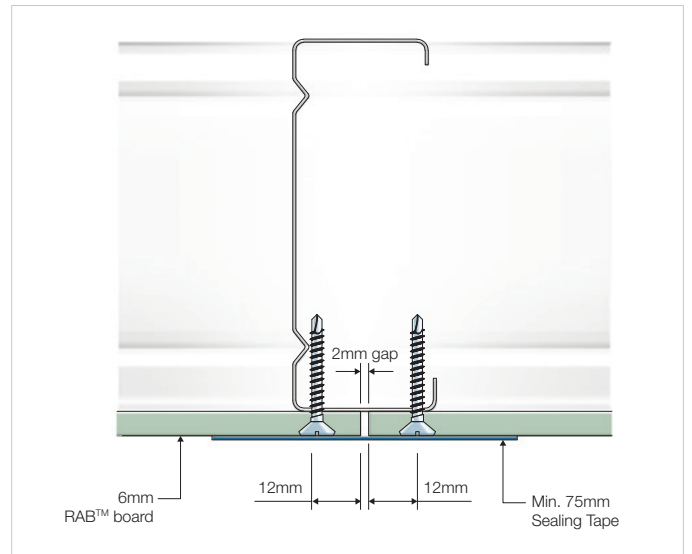

FIGURE 11 VERTICAL JOINT

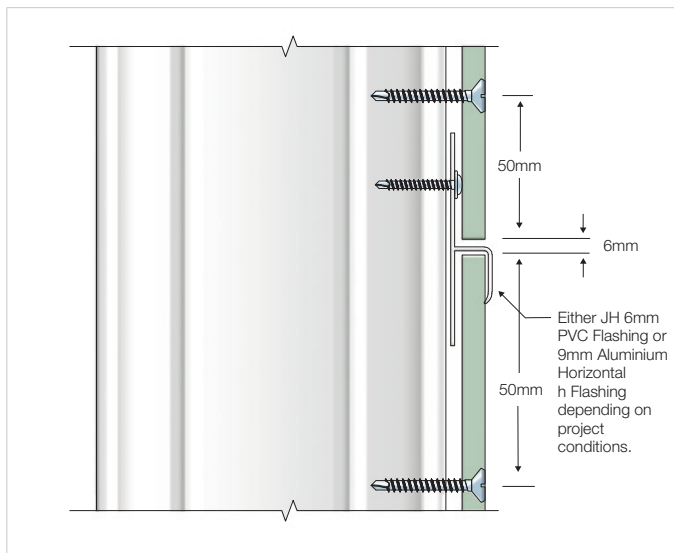

FIGURE 12 HORIZONTAL JOINT

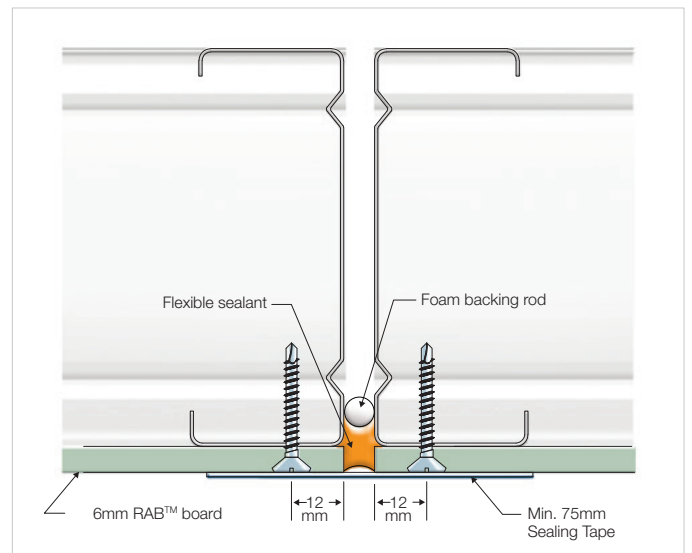

FIGURE 13 VERTICAL CONTROL JOINT

Corners

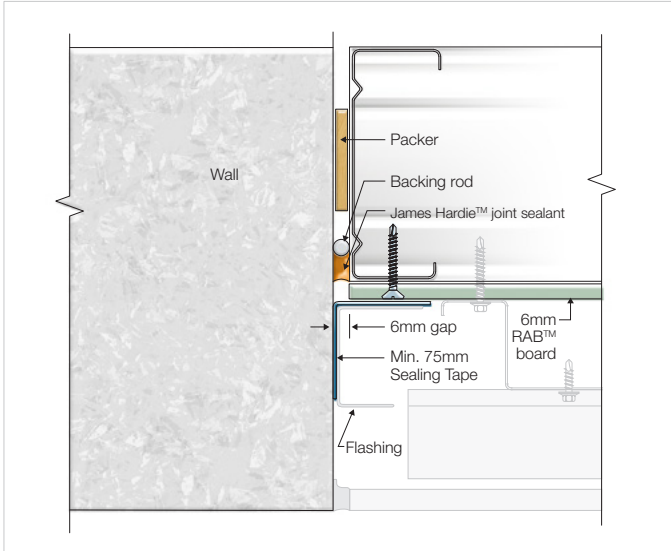

FIGURE 14 ABUTMENT TO MASONRY WALL FOR BALCONY INFILL

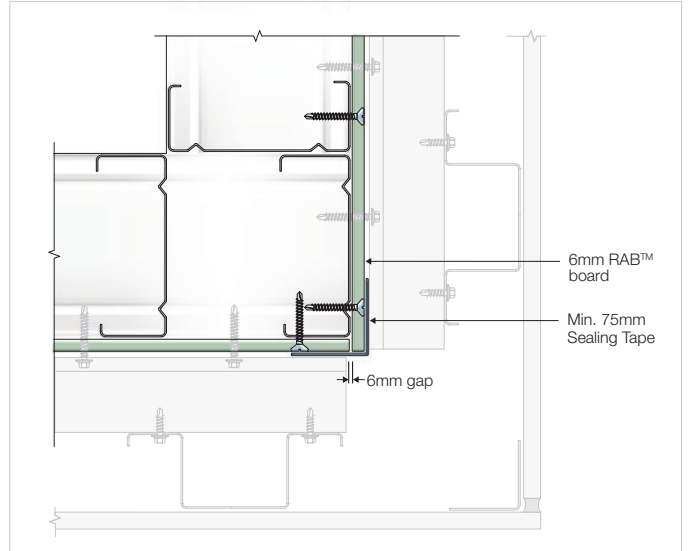

FIGURE 15 EXTERNAL CORNER

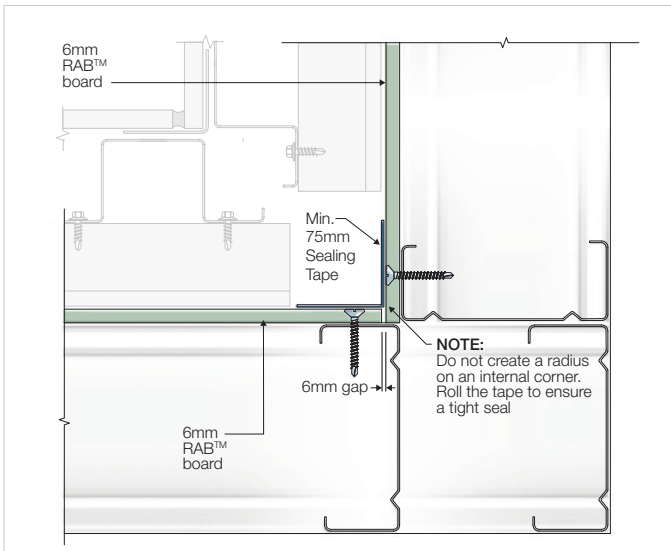

FIGURE 16 INTERNAL CORNER

Windows

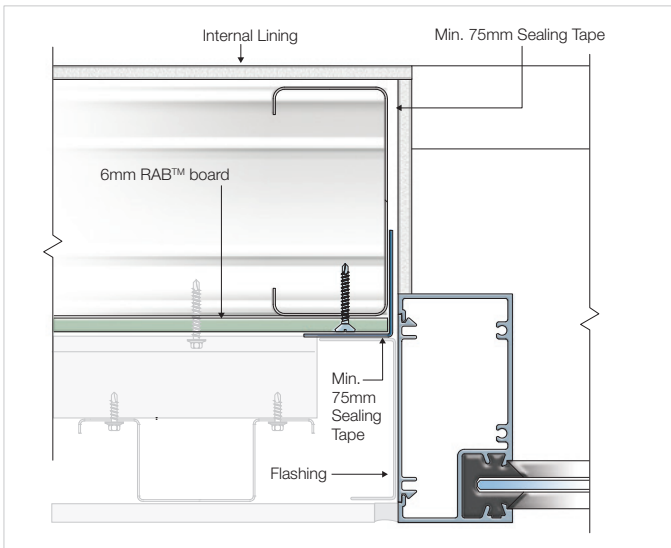

FIGURE 17 FLUSH WINDOW JAMB

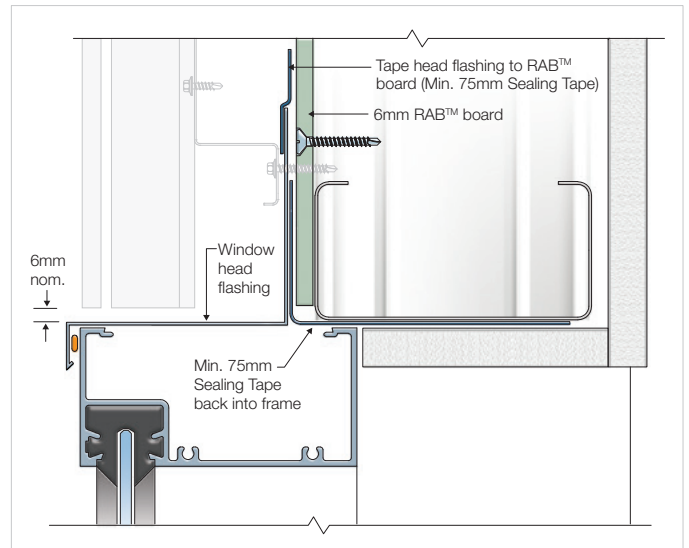

FIGURE 18 FLUSH WINDOW HEAD

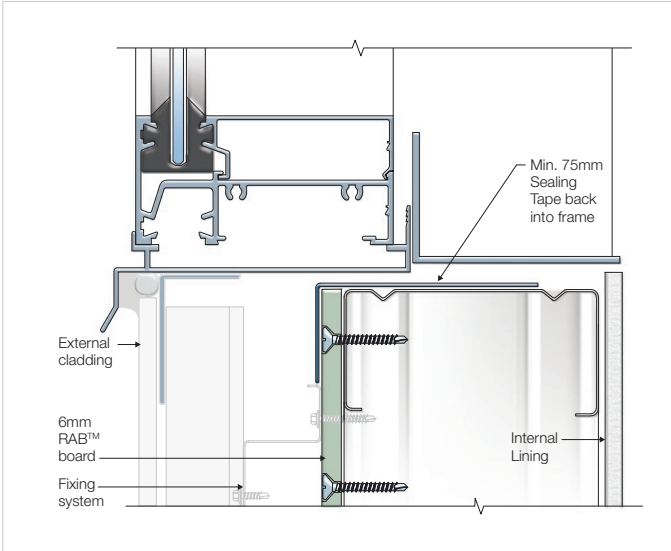

FIGURE 19 FLUSH WINDOW SILL

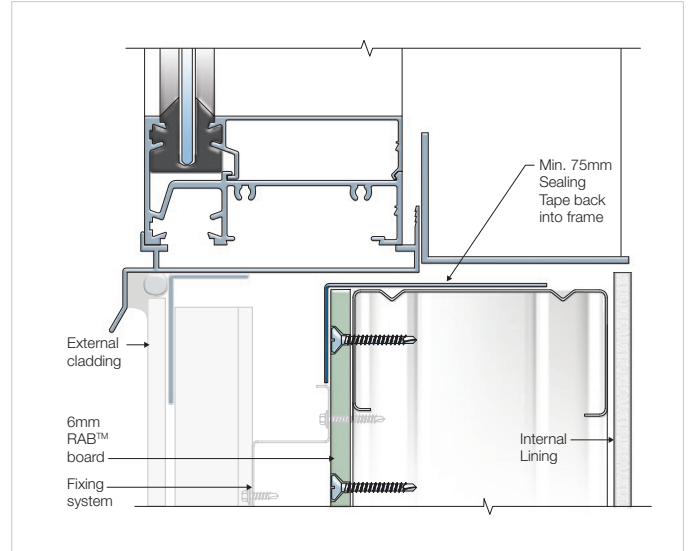

FIGURE 20 FLUSH WINDOW SILL

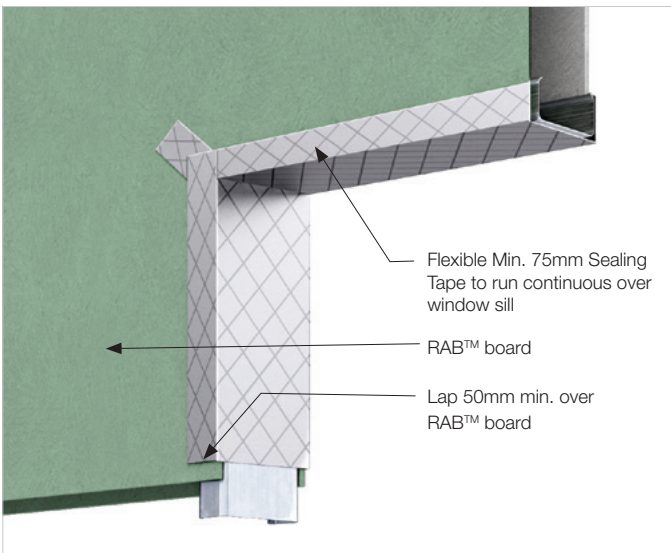

FIGURE 21 WINDOW CORNER TAPING DETAIL

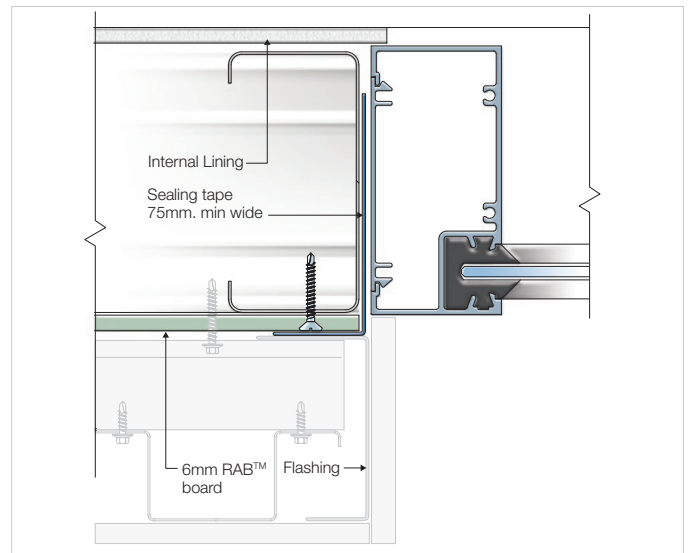

FIGURE 22 RECESSED WINDOW JAMB

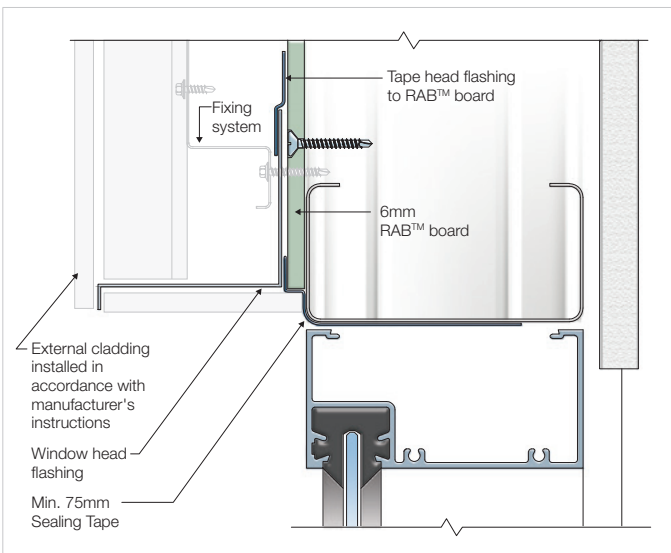

FIGURE 23 RECESSED WINDOW HEAD

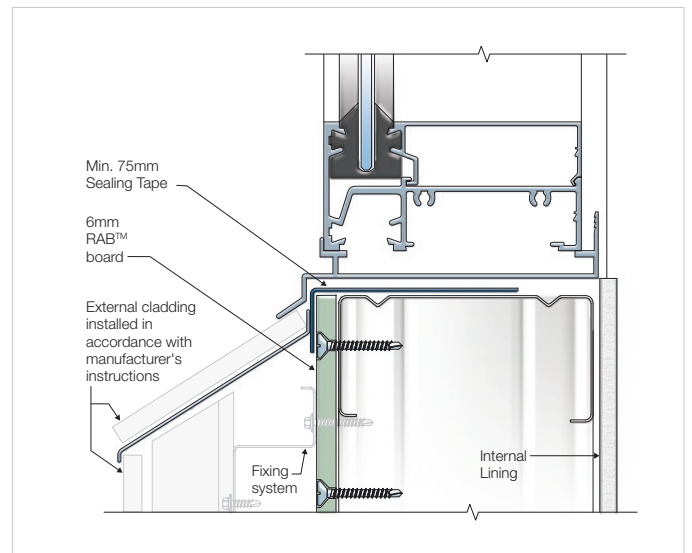

FIGURE 24 RECESSED WINDOW SILL

Parapet

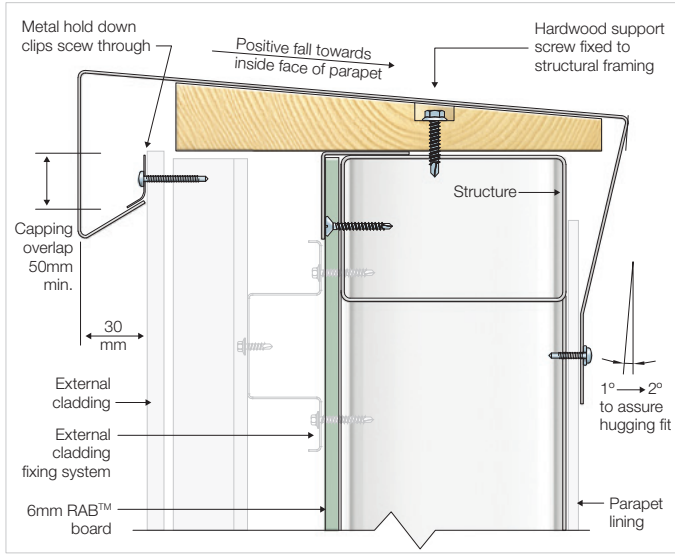

FIGURE 25 PARAPET DETAIL

Penetrations

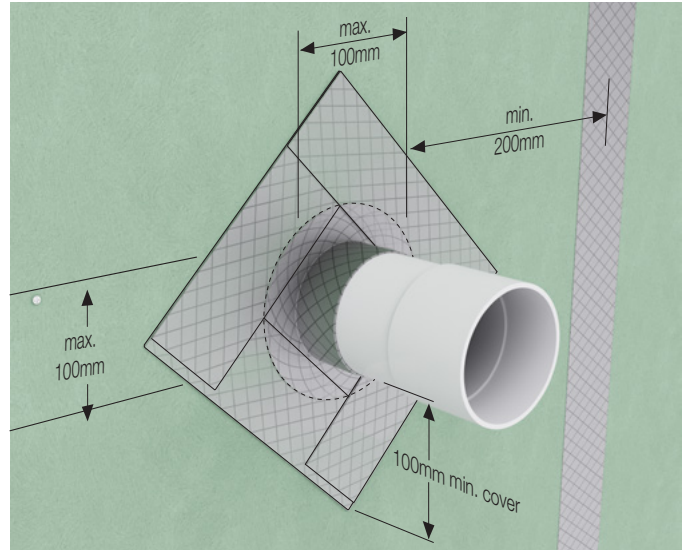

FIGURE 26 PIPE AND OTHER PENETRATIONS



**For information and advice
call 13 11 03 | jameshardie.com.au**

Australia May 2020



© 2020 James Hardie Australia Pty Ltd ABN 12 084 635 558
™ and ® denote a trademark or registered mark owned by James Hardie Technology Limited.