



Installation Guide

Scyon™ Secura™
Interior Flooring

INTERIORS

Australia June 2020

Make sure your information is up to date.

When specifying or installing James Hardie™ products, ensure you have the current installation guide. If in doubt, or you need more information, visit www.jameshardie.com.au or Ask James Hardie™ on 13 11 03.

IMPORTANT NOTES

- This product is two sided with a dual function. For internal tiled applications, install sheet with label 'This side DOWN for TILES' facing down. For internal vinyl/carpet applications, install sheet with label 'This side UP for VINYL' facing up.
- Scyon™ Secura™ Interior flooring is not suitable for external use.
- Failure to install, finish or maintain this product in accordance with applicable building codes, regulations, standards and this guide may lead to personal injury, affect system performance, violate local building codes, and void James Hardie's product warranty.

SCYON™ SECURA™ INTERIOR FLOORING						
PRODUCT		DESCRIPTION				
<p>19mm or 22mm</p> <p>Tiled Application Vinyl Application</p> <p>Long Edge Sheet Join Options</p>		A sealed multi purpose structural flooring product for both tiled or vinyl/carpet covered internal flooring applications. <ul style="list-style-type: none"> 19mm thick Scyon™ Secura™ Interior flooring board has clear sealed edges. 22mm thick Scyon™ Secura™ Interior flooring board has dark grey edges. Long edges have a tongue and groove feature for easy jointing.				
		SIZE MM (NOMINAL)				
Width	Length	Thickness	Max Supports (mm)	Mass (kg)	Part No.	Units pack
600	2700	19	450	40	404050	20
600	2400	22	600	41	404689	20
600	2400	22	600	41	404691	20

NOTES

- All dimensions and masses provided are approximate only and subject to manufacturing tolerances. Masses are based on approximate moisture content of product leaving manufacturing plant.

PRODUCT / ACCESSORIES / TOOLS			
SUPPLIED BY JAMES HARDIE			
ACCESSORIES	DESCRIPTION	ACCESSORIES	DESCRIPTION
	HardieBlade™ Saw Blade. 185mm diameter A 185mm diameter poly-diamond blade for fast and clean cutting of James Hardie fibre cement. 1 each. Part No. 300660		James Hardie™ Joint Sealant. 300ml cartridge and 600ml Sausage A general purpose, paintable, exterior grade polyurethane joint sealant. Used for sealing of all sheet joints and can be used to adhere sheets to framing.
	HardieDrive™ Screw 41mm long. A class 3 self-tapping wing-tipped screw for fastening to 0.5mm to 1.6mm BMT light gauge steel frames. 1000 per box. Part No. 305984		300ml tube 20 per box. 1 each. Part No. 305534
	HardieDrive™ Screw 41mm long. A class 3 self-tapping wing-tipped screw for fastening to 0.5mm to 1.6mm BMT light gauge steel frames. Suitable for use in most auto feed screw guns. 1000 per box. Part No. 305982		600ml sausage 20 per box. 1 each. Part No. 305672
NOT SUPPLIED BY JAMES HARDIE James Hardie recommends the following products for use in conjunction with its Scyon™ Secura™ Interior flooring. James Hardie does not supply these products and does not provide a warranty for their use. Please contact the product manufacturer for information on their warranties and further information on their products.			
ACCESSORIES	DESCRIPTION	ACCESSORIES	DESCRIPTION
	Nails <ul style="list-style-type: none"> 2.8 x 50mm corrosion resistant fibre cement nails. 50mm corrosion resistant D Head gun nails. 		Gun Nailer Suitable pneumatic or coil gun nailer.
	Ring Shank Nail Paslode 50 x 2.87mm Amor Galvanised Dekfast Impulse Nail for fixing Scyon Secura Flooring to narrow I-joists.		Cordless Drill Recommended tool for screw fixing the sheets to steel and timber framing.
	Screws N° 8 x 40mm Corrosion resistant self embedding head for screwing to timber framing.		Spatula For spreading adhesive over all sheet joints and fasteners
	QuikDrive Collated Screw 42mm long Class 3 screw for fixing to 0.8 - 1.6mm BMT steel framing. Part No. CBSDG158SA		M class or higher vacuum Required to reduce the exposure to respirable dust and crystalline silica.
	Dust-reducing saw with M class or higher vacuum extraction Dust reducing saw with a HardieBlade™ saw blade. Makita 5057KB / Hitachi C7YA.		Backing Rod Used to create control joints. 10mm diameter
	Construction Adhesive Suitable construction adhesive for gluing sheets to floor frame. James Hardie joint sealant may be used		

WARNING - DO NOT BREATHE DUST AND CUT ONLY IN WELL VENTILATED AREA

James Hardie products contain sand, a source of respirable crystalline silica. **May cause cancer if dust from product is inhaled. Causes damage to lungs and respiratory system through prolonged or repeated inhalation of dust from product.**

Intact fibre cement products are not expected to result in any adverse toxic effects. The hazard associated with fibre cement arises from the respirable crystalline silica present in dust generated by activities such as cutting, rebating, drilling, routing, sawing, crushing, or otherwise abrading fibre cement, and when cleaning up, disposing of or moving dust.

When doing any of these activities in a manner that generates dust, follow James Hardie instructions and best practices to reduce or limit the release of dust, warn others in the area and consider rotating personnel across the cutting task to further limit respirable silica exposure.

If using a dust mask or respirator, use an AS/NZS1716 P1 filter and refer to Australian/New Zealand Standard 1715:2009 Selection, Use and Maintenance of Respiratory Protective Equipment for more extensive guidance and more options for selecting respirators for workplaces. For further information, refer to our installation instructions and Safety Data Sheets available at www.jameshardie.com.au. **FAILURE TO ADHERE TO OUR WARNINGS, SAFETY DATA SHEETS, AND INSTALLATION INSTRUCTIONS MAY LEAD TO SERIOUS PERSONAL INJURY OR DEATH.**

JAMES HARDIE RECOMMENDED SAFE WORKING PRACTICES

CUTTING OUTDOORS

- Position cutting station so wind will blow dust away from the user or others in working area.
- Warn others in the area to avoid dust.
- Consider rotating personnel across cutting tasks to further limit respirable silica exposures.
- Use one of the following methods based on the required cutting rate:
 - Best ▪ Villaboard™ knife ▪ Hand guillotine ▪ Fibreshear
 - Better ▪ Position the cutting station in a well-ventilated area. Use a dust reducing circular saw equipped with HardieBlade™ Saw Blade or comparable fibre cement blade and well maintained M-class vacuum or higher with appropriate filter for capturing fine (respirable) dust. Wear a properly-fitted, approved dust mask or respirator (minimum P1).

CUTTING INDOORS

- Cut only using Villaboard™ knife, hand guillotine or fibreshears (manual, electric or pneumatic).
- Position cutting station in a well-ventilated area.

DRILLING/OTHER MACHINING

When drilling or machining you should always wear a P1 dust mask and warn others in the immediate area.

IMPORTANT NOTES

- For maximum protection (lowest respirable dust production) James Hardie recommends always using best practice cutting methods where feasible.
- NEVER use a power saw indoors or in a poorly ventilated area.
- ALWAYS use a dust reducing circular saw equipped with a sawblade specifically designed to minimise dust creation when cutting fibrecement - preferably a sawblade that carries the HardieBlade™ logo or one with at least equivalent performance - connected to a M class or higher vacuum.
- NEVER dry sweep - Use wet suppression, or an M class vacuum or higher with appropriate filter.
- NEVER use grinders.
- ALWAYS follow tool manufacturers' safety recommendations.
- ALWAYS wear a properly fitted, approved dust mask, P1 or higher

DUST MASKS AND RESPIRATORS

As a minimum, an AS/NZS1716 P1 respirator must be used when doing any activity that may create dust. For more extensive guidance and options for selecting respirators for workplaces please refer to Australian/New Zealand Standard 1715:2009 "Selection, Use and Maintenance of Respiratory Protective Equipment". P1 respirators should be used in conjunction with the above cutting practices to minimise dust exposure. For further information, refer to Safety Data Sheet (SDS) available at www.jameshardie.com.au. If concern still exists about exposure levels or you do not comply with the above practices, you should always consult a qualified industrial hygienist or contact James Hardie for further information.

STORAGE AND HANDLING

To avoid damage, all James Hardie™ building products should be stored with edges and corners of the product protected from chipping. James Hardie™ building products must be installed in a dry state and protected from weather during transport and storage. The product must be laid flat under cover on a smooth level surface clear of the ground to avoid exposure to water, moisture, etc.

SCOPE AND OVERVIEW

This installation guide covers the use of Scyon™ Secura™ Interior flooring sheets in a vinyl/carpet and tiled application in an internal application over timber or light gauge steel frames.

DESIGN

General

All design and construction must comply with the appropriate requirements of the current National Construction Code (NCC) and other applicable regulations and standards.

Responsibility

The specifier or other party responsible for the project must ensure that the details in this guide are appropriate for the intended application and that additional detailing is performed for specific design or any areas that fall outside the scope of this guide.

Loading

For residential indoor applications, both 19mm and 22mm Scyon™ Secura™ Interior flooring sheets satisfy the concentrated load and Uniformly Distributed Load (UDL) of 1.8kN and 2kPa respectively with floor joist centres indicated in table 1.

TABLE 1. MAXIMUM FLOOR JOIST CENTRES

SHEET THICKNESS (MM)	JOIST CENTRE (MM)
19 mm	450
22 mm	600

For commercial applications, 22mm Scyon™ Secura™ Interior flooring sheets are structurally designed to withstand various loads categories in Table 3.1 of AS/NZS 1170.1 – Structural design actions – Permanent, imposed and other actions' for unfactored working stress loads stated in Table 2.

TABLE 2. MAXIMUM FLOOR JOIST CENTRES

THICKNESS (MM)	JOIST CENTRE (MM)	POINT LOAD (0.01M ² SIZE)	UDL ALLOWABLE
22	450	3.6 kN	5kPa
22	600	2.7kN	5kPa

FRAMING

General

Scyon™ Secura™ Interior flooring may be fixed to either durable timber or corrosion resistant light gauge steel frame joist centres. Floor joist must be a nominal of 45mm wide (except for Narrow Timber I Joists and LVL solid joist).

Framing must have the appropriate level of durability required to prevent corrosion or deterioration.

Timber Framing

Use of timber framing must be in accordance with AS1684 - 'Residential timber-framed construction', dry kiln, and in accordance with the framing manufacturer's specifications.

- Narrow Timber I Joists (min. 40mm wide): Refer to table 3 for specific fastener requirements. The flange of the joist profile must have an adequate depth to ensure full fastener embedment.
- LVL solid joist (min. 42mm wide): Refer to table 3 for specific fastener requirements.

Steel Framing

Framing members must have a 0.75mm to 1.9mm BMT (base metal thickness) and be in accordance with NASH standard for Residential and Low Rise Steel Framing Part 1 and manufacturer's specifications.

Tolerances

Framing is to be straight and true. Suggested frame tolerance in all directions is 3-4mm over 3m.

FASTENERS

TABLE 3. FASTENER SELECTION

PRODUCT	TIMBER JOISTS (MIN 4MM WIDE)	NARROW I-JOIST	LVL SOLID JOIST	STEEL JOISTS 0.75 - 1.6MM BMT	STEEL JOISTS 1.6 - 1.9MM BMT
2.8 x 50mm FC nails	✓				
50mm D Head gun nails	✓				
No.8 x 40mm CSK self drilling screw	✓	✓	✓		
40mm Hardie-Drive screw				✓	
40mm CSK self drilling screw					✓*
50 x 2.87mm DekFast Ring D Head nail	✓	✓	✓		

NOTE: All fasteners must have a minimum Class 3 finish. * Refer to manufacturer's specifications for suitability.

SHEET LAYOUT AND SIDE UP

Install sheets across the floor joists with the short sheet edges fully supported on joists in a staggered pattern. For internal tiled applications, install sheet with label 'This side DOWN for TILES' facing down. For internal vinyl/carpet applications, install sheet with label 'This side UP for VINYL' facing up.

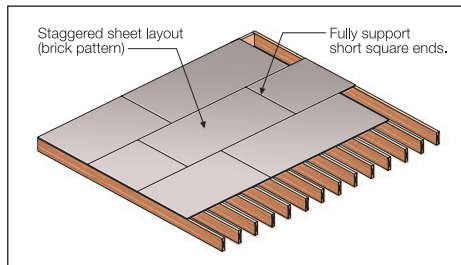

FIGURE 1 SHEET LAYOUT - TILING AND VINYL

INSTALLATION STEPS

NOTES

- Ensure the product meets aesthetic and product size specifications before installation. James Hardie will not be responsible for rectifying aesthetic surface variations following installation.
- The sheet is multi purpose and depending on the finish, the short sheet ends may or may not need a gap. As a result, creep at the short sheet ends will occur and over many sheets additional floor joists may be required.

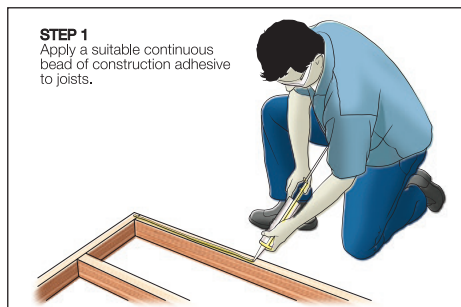

FIGURE 2 CONSTRUCTION ADHESIVE

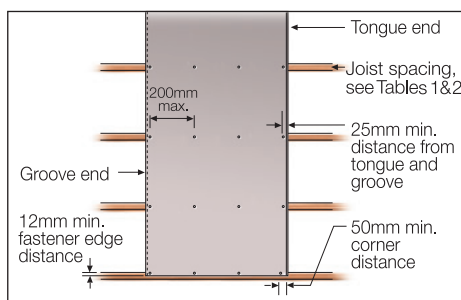

FIGURE 3 FASTENER LAYOUT

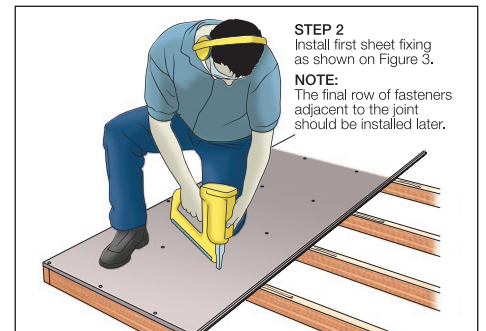

FIGURE 4 FIXING 1ST PANEL

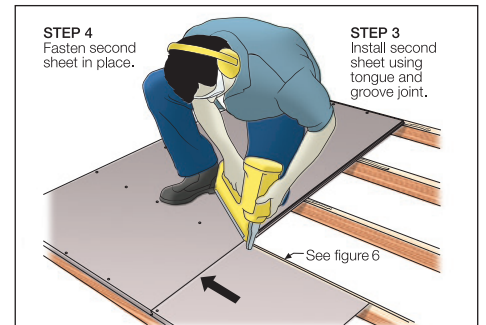
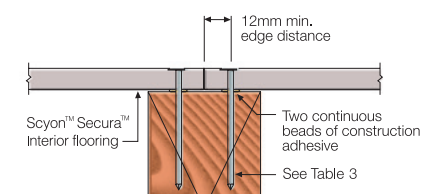

FIGURE 5 FIXING 2ND PANEL

FOR INTERNAL DRY AREAS



For Internal Dry Area butt joints - Tile and Vinyl

FOR INTERNAL TILED WET AREAS ONLY

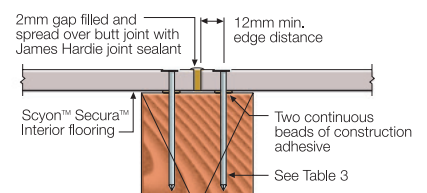

For Internal Wet Area butt joints - Tiled

FIGURE 6 BUTT JOINING OPTIONS

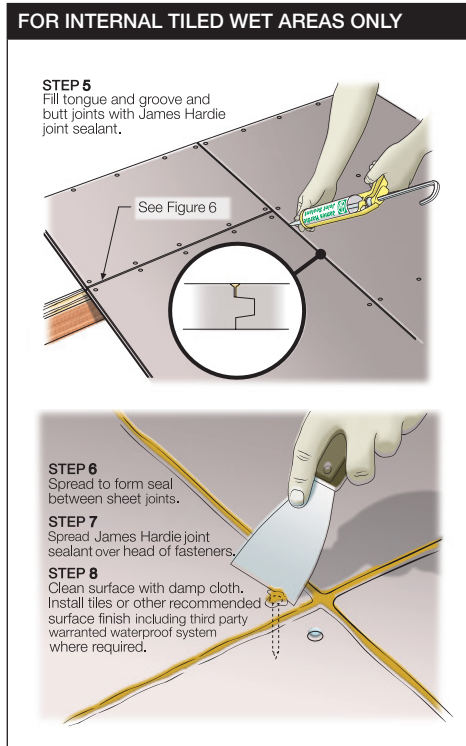

FIGURE 8 SEALING FASTENER JOINTS - WET AREAS
NOTE: Avoid excessive foot traffic on the floor for at least 24-48 hours to allow sealant to set and dry out. Protect the surface of the sheets from damage until final finish is applied.

CONTROL JOINTS

Tiled dry and wet areas only

Control joints in the floor sheets and thus through the tiles are required in dry and wet areas where floor dimensions exceed 5.4m in the long sheet direction and where existing structural joints are located, see below. For 22mm Scyon™ Secura™ Interior flooring, it may be more practical to have the control joints every 4.8 metres along the length of the sheets to coincide with sheet size.

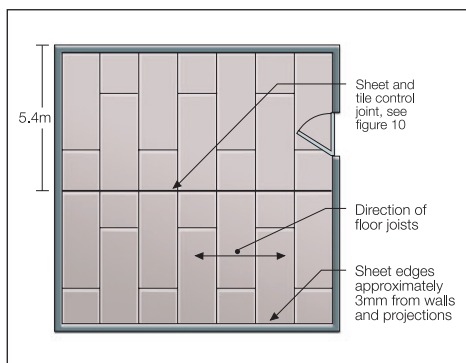

FIGURE 8 SHEET CONTROL JOINT LAYOUT

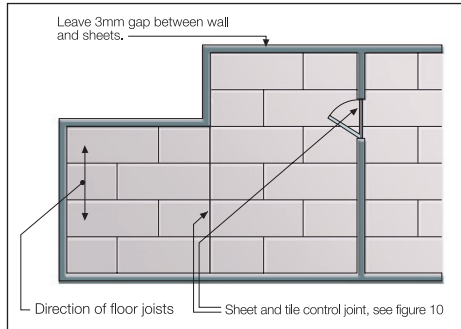

FIGURE 9 L-SHAPED ROOM

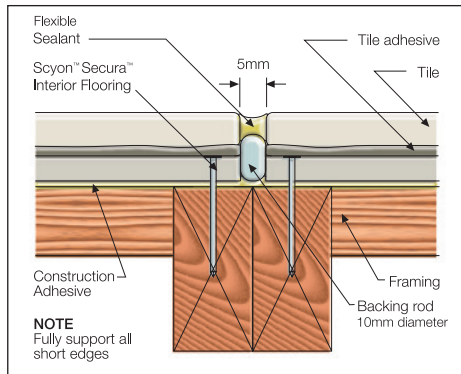

FIGURE 10 CONTROL JOINTS - SHEET & TILE JOINT

Additional control joints in the tiles are required in both directions, refer to AS3958.1 and Figure 11 for more information.

NOTE: No control joints are required in the flooring sheets when finishing with vinyl and carpet unless there is an existing structural joint or otherwise specified by relevant code and regulation.

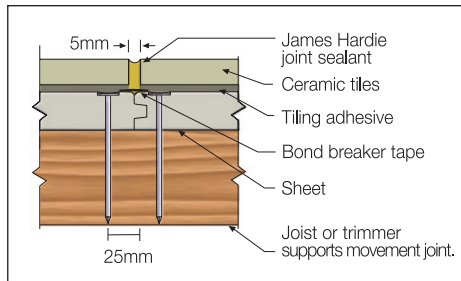

FIGURE 11 CONTROL JOINTS - TILE

FINISHES

Ensure all components are fully compatible with one another and warranted for the intended application with Scyon™ Secura™ Interior flooring including tiles, vinyl, and waterproofing system and tile and vinyl adhesive.

Preparation

Where minor height variations (3mm or less) occur at sheet butt joints, these may be levelled out by filling with Ardex's Feather Finish. Sanding of the Scyon™ Secura™ Interior flooring is not recommended. Ensure sheets are fully dry and clean before applying finishes.

Wet Areas

This guide must be read in conjunction with James Hardie's Wet Area Construction application guide, AS 3740, AS 3958.1 and the National Construction Code (NCC). Install floor tiles in accordance with tile manufacturer's specifications within 3 months of installation.

At the time of writing the following third party companies for warranted waterproofing systems for use with Scyon™ Secura™ Interior flooring.

- Ardex Australia Pty Ltd
- Bostik Australia Pty Ltd
- Crommelin
- ParexDavco Australia.

Vinyl

In Internal wet and dry areas, vinyl can be directly fixed to the sheets. In high risk areas of a wet area eg. shower, a warranted and tested waterproofing system is required.

As the sheets are sealed, it recommended that the vinyl adhesive is allowed to air dry longer to become tacky before laying down the vinyl sheets. Dunlop® Vinyl Adhesive, Polymer Vinyl Adhesive 265 from Polymer Engineering and Fullers® Perfect Putdown floor adhesive are water based and may be used.

Refer to the above vinyl manufacturers for suitable warranted tested products and installation instructions.

Tiling

In Internal wet and dry areas, tiles can either be directly fixed to the sheets or laid on a sand-cement mortar bed over the sheets. Brittle tile finishes such as slate and marble may need to be laid on a 30mm thick reinforced bed. Refer to tile supplier for warranted specifications and AS 3958.1.

Tiles must be applied with proprietary flexible adhesive applicable for tile thickness and size nominated in code and by tile adhesive company that conforms to ISO 13007.1 for Ceramic Tiles and Adhesives. Use a flexible tile adhesive that is warranted and is suitable for use with Scyon™ Secura™ Interior flooring and tiles used.

Tiles are laid from the control joint out and edges of tiles must overlap butt joints a minimum of 50mm.

Refer to the waterproofing and tile manufacture and relevant tiling codes for maximum tile control joint spacing, tile adhesive thickness and application, product suitability and compatibility including grout, tile adhesive, tile and waterproofing warranty and maintenance requirement.

MAINTENANCE

Cleaning and maintenance of the finished surface, joints, junctions, penetrations etc must be carried out at regular intervals. Maintain waterproofing to meet the objectives of AS 3740 and as per the requirements of the relevant component manufacturer.

PRODUCT INFORMATION

General

The basic composition of James Hardie™ building products is Portland cement, ground sand, cellulose fibre, water and proprietary additives.

James Hardie™ building products are manufactured AS/NZS 2908.2 'Cellulose-Cement Products-Flat Sheet'. These are also compliant with equivalent standard ISO 8336 'Fibre-cement flat sheets - Product specification and test methods'. For product classification refer to the relevant Physical Properties Data Sheet.

Durability

Resistance to fire

James Hardie flooring products have been tested to AS/ISO 9239, and exceed the requirements stipulated in the National Construction Code (NCC) - Specification C1.10a Fire Hazard Properties – Floors, Walls & Ceilings. All James Hardie flooring products have critical radiant flux values greater than the minimum requirement of 4,5 kW/m² (highest value in accordance with Table 1), and a smoke development rate well below the maximum allowable smoke development rate of 750 percentage-minutes.

Resistance to termite attack

Based on testing completed by CSIRO Division of Forest Products and Ensis Australia James Hardie building products have demonstrated resistance to termite attack.

WET AREAS APPRAISAL

Scyon™ Secura™ Interior flooring has been appraised by CSIRO (Technical Assessment 318, July 2005) as satisfying the relevant requirements for use in internal wet areas.

SCYON™ SECURA™ INTERIOR FLOORING PRODUCT WARRANTY

Scyon™ Secura™ Interior flooring sheets have a 10 year product warranty. For terms and conditions of product warranty, refer to www.scyon.com.au, www.accel.com.au or Ask James Hardie on 13 11 03

© Copyright 2013 James Hardie Australia Pty Ltd.
ABN 12 084 635 558. ™ and ® denotes a trademark or registered mark owned by James Hardie Technology Limited

Notes



**For information and advice
call 13 11 03 | [jameshardie.com.au](https://www.jameshardie.com.au)**

Australia June 2020



© 2020 James Hardie Australia Pty Ltd ABN 12 084 635 558
™ and © denote a trademark or registered mark owned by James Hardie Technology Limited.