



Installation Guide

Scyon™ Stria™
Cladding

EXTERIORS

Australia June 2020

Make sure your information is up to date.

When specifying or installing James Hardie™ products, ensure that you have the current technical information and guides. If in doubt, or you need more information, visit www.jameshardie.com.au or Ask James Hardie™ on 13 11 03.

Installation Guide

Made in Australia

IMPORTANT NOTES

1. Failure to install, finish or maintain this product in accordance with applicable building codes, regulations, standards and James Hardie's written application instructions may lead to personal injury, affect system performance, violate local building codes, and void James Hardie's product warranty.
2. All warranties, conditions, liabilities (direct, indirect or consequential) and obligations whether arising in contract, tort, industry negligence or otherwise other than those specified in James Hardie's product warranty are excluded to the fullest extent allowed by law. For James Hardie's product warranty information and disclaimers about the information in this guide, refer to www.jameshardie.com.au
3. The builder must ensure the product meets aesthetic requirements before installation. James Hardie™ will not be responsible for rectifying aesthetic surface variations following installation.
4. Make sure your information is up to date. When specifying or installing James Hardie™ products, ensure you have the current guide. If in doubt, or you need more information, visit www.jameshardie.com.au or Ask James Hardie™ on 13 11 03.

SCYON™ STRIA™ CLADDING AND SCYON™ AXENT™ TRIM

| PRODUCT | DESCRIPTION | SIZE (NOMINAL) | | | COVERAGE INFORMATION | | | | |
|---------|---|----------------|------------|----------------|----------------------|-----------------------------|---------------|-----------|------------------|
| | | Length (mm) | Width (mm) | Thickness (mm) | Effective Cover (mm) | No. of boards /metre height | Mass kg/lin m | Mass kg/m | Pallet weight kg |
| | Scyon™ Stria™ cladding Standard and Wide Profiles A pre-primed board to create a 15mm horizontal and vertical joint design on external and internal walls. Standard Part No. 404063 | 4200 | 325 | 14 | 300 | 3.3 | 5.8 | 18.9 | 1585 (60/pack) |
| | Wide Part No. 404413 | 4200 | 405 | 14 | 380 | 2.6 | 7.7 | 18.9 | 1320 (40/pack) |
| | Scyon™ Stria™ cladding Splayed Profile A pre-primed board to create a splayed shiplap horizontal joint design on external and internal walls. Splayed Part No. 404522 | 4200 | 255 | 16 | 230 | 4.3 | 4.9 | 21.6 | 1206 (60/pack) |

Scyon™ Axent™ trim - Refer to current Scyon™ Axent™ trim guide for sizes.

NOTES

1. All dimensions and masses provided are approximate only and subject to manufacturing tolerances. Masses are based on equilibrium moisture content of product.

ACCESSORIES / TOOLS SUPPLIED BY JAMES HARDIE™

| ACCESSORIES | DESCRIPTION | ACCESSORIES | DESCRIPTION |
|-------------|--|-------------|--|
| | Stria™ Vertical Flashing Stop. 3,000mm long For use with Scyon™ Stria™ cladding behind boards at vertical joints. 5 per pack. Part No. 305547 | | Stria™ Aluminium External Box Corner 3,000mm long. A ready to paint aluminium extrusion to be used with Scyon™ Stria™ cladding standard and wide profile to create external boxed corners. 5 per pack. Part No. 305519 |
| | HardieBlade™ Saw Blade. 185mm diameter A 185mm diameter poly-diamond blade for fast and clean cutting of James Hardie™ fibre cement. 1 each. Part No. 300660 | | JH 16mm Aluminium External Trim Corner 3,000mm long. A ready to paint aluminium extrusion to be used with Scyon™ Stria™ cladding - Splayed Profile to create external boxed corners. 5 per pack. Part No. 305630 |
| | Stria™ 14mm Aluminium Internal Corner 3,000mm long A ready to paint aluminium extrusion to be used with Scyon™ Stria™ cladding standard and wide profiles to create internal corners. 5 per pack. Part No. 305518 | | HardieDrive™ Screw 41mm long A class 3 self-tapping wing-tipped screw for fastening to 0.5mm to 1.6mm BMT light gauge steel frames. 1000 per box. Part No. 305984 |
| | HardieBreak™ Thermal Strip A building code requirement to be installed behind James Hardie™ external cladding over metal framing and HardieWrap™ weather barrier. 42x12x2750mm. Refer to HardieBreak™ thermal strip installation guide. 45 per pack. Part No. 305612 | | HardieDrive™ Collated Screw 41mm long A class 3 self-tapping wing-tipped screw for fastening to 0.5mm to 1.6mm BMT light gauge steel frames. Suitable for use in most auto feed screw guns. 1000 per box. Part No. 305982 |
| | HardieEdge™ Trim An architectural slab edge solution fabricated from high-quality powder coated aluminium. Unit size: 3950mm. 4 per pack. Part No. 305911 Also available: Base Trim Jointer 12 per pack. Part No. 305912 Internal Corner 4 per pack. Part No. 305913 External Corner 4 per pack. Part No. 305914 | | James Hardie™ Joint Sealant. 300ml cartridge A general purpose, paintable, exterior grade polyurethane joint sealant. 20 per box. Part No. 305534 |
| | HardieWrap™ Weather Barrier A non-perforated, highly breathable and reflective safe-glare weather barrier designed to be used behind Scyon™ external cladding products to help protect the building. For alternate products, please refer to the HardieWrap™ weather barrier section (p.2) Unit size 2750mm x 3000mm Part No. 305664. | | James Hardie™ Aluminium Internal Corner Mould. 3,600mm long. A ready to paint aluminium used with 16mm Scyon™ Stria™ cladding Splayed Profile. Part No. 305511 |
| | | | James Hardie™ 75x75mm COLORBOND™ Corner Flashing. 3,000mm long A COLORBOND™ corner flashing for use behind cladding at internal and external corners. 5 per pack. Part No. 305564 |

COMPONENTS NOT SUPPLIED BY JAMES HARDIE™ James Hardie recommends the following products for use in conjunction with its Scyon™ Stria™ cladding and Scyon™ trim. James Hardie does not supply these products and does not provide a warranty for their use. Please contact component manufacturer for information on their warranties and further information on their products.

| | | | |
|--|--|--|---|
| | 40 and 50 x 2.8mm fibre cement nails Minimum Class 3 (see fastener durability section) 40mm for concealed fixing, 50mm for face fixing. | | Bostik Seal 'N' Flex 1 A suitable replacement for where James Hardie™ joint sealant is specified (supplied in sausage form). |
| | ND or DA Stainless Steel Brad Nail 14 gauge x 50mm ND or DA stainless steel nail for an alternative to fixing Scyon™ Stria™ cladding to frame. Two per board and suitable up to N3 only, refer to tables 1 and 2. | | Compound mitre saw with M class or higher vacuum extraction Dust reducing compound mitre saw used with HardieBlade™ saw blade. Makita: LS0714/LS1013/LS1212 Hitachi: C10FSB/C12FSB |
| | Quikdrive Collated Screw 40mm long Class 3 galvanised screw for fixing to 0.8-1.6mm BMT steel framing. | | Gun nails and nailers Suitable gun nails and nailers for face fixing to timber framing only. Minimum nail length of 50mm is required. Refer to fastener section. Minimum Class 3. |
| | Bond Breaking Tape Used behind sealant at joints, refer to this document for more information. | | M class or higher vacuum Required to reduce the exposure to respirable dust and crystalline silica. |

* Highly corrosive environments and areas within 1km of the coast require Class 4 or stainless steel coatings. Refer to the fastener manufacturer for recommendations.

WARNING - DO NOT BREATHE DUST AND CUT ONLY IN WELL VENTILATED AREA

James Hardie products contain sand, a source of respirable crystalline silica. **May cause cancer if dust from product is inhaled. Causes damage to lungs and respiratory system through prolonged or repeated inhalation of dust from product.**

Intact fibre cement products are not expected to result in any adverse toxic effects. The hazard associated with fibre cement arises from the respirable crystalline silica present in dust generated by activities such as cutting, rebating, drilling, routing, sawing, crushing, or otherwise abrading fibre cement, and when cleaning up, disposing of or moving dust.

When doing any of these activities in a manner that generates dust, follow James Hardie instructions and best practices to reduce or limit the release of dust, warn others in the area and consider rotating personnel across the cutting task to further limit respirable silica exposure. If using a dust mask or respirator, use an AS/NZS1716 P1 filter and refer to Australian/New Zealand Standard 1715:2009 Selection, Use and Maintenance of Respiratory Protective Equipment for more extensive guidance and more options for selecting respirators for workplaces. For further information, refer to our installation instructions and Safety Data Sheets available at www.jameshardie.com.au. FAILURE TO ADHERE TO OUR WARNINGS, SAFETY DATA SHEETS, AND INSTALLATION INSTRUCTIONS MAY LEAD TO SERIOUS PERSONAL INJURY OR DEATH.

JAMES HARDIE RECOMMENDED SAFE WORKING PRACTICES

CUTTING OUTDOORS

1. Position cutting station so wind will blow dust away from the user or others in working area.
2. Warn others in the area to avoid dust.
3. Consider rotating personnel across cutting tasks to further limit respirable silica exposures.
4. Use one of the following methods based on the required cutting rate:
Best ▪ Villaboard™ knife ▪ Hand guillotine ▪ Fibreshear Better ▪ Position the cutting station in a well-ventilated area. Use a dust reducing circular saw equipped with HardieBlade™ Saw Blade or comparable fibre cement blade and well maintained M-class vacuum or higher with appropriate filter for capturing fine (respirable) dust. Wear a properly-fitted, approved dust mask or respirator (minimum P1).

CUTTING INDOORS

- Cut only using Villaboard™ knife, hand guillotine or fibreshears (manual, electric or pneumatic).
- Position cutting station in a well-ventilated area.

DRILLING/OTHER MACHINING

When drilling or machining you should always wear a P1 dust mask and warn others in the immediate area.

IMPORTANT NOTES

1. For maximum protection (lowest respirable dust production) James Hardie recommends always using best practice cutting methods where feasible.
2. NEVER use a power saw indoors or in a poorly ventilated area.
3. ALWAYS use a dust reducing circular saw equipped with a sawblade specifically designed to minimise dust creation when cutting fibre cement - preferably a sawblade that carries the HardieBlade™ logo or one with at least equivalent performance - connected to a M class or higher vacuum.
4. NEVER dry sweep - Use wet suppression, or an M class vacuum or higher with appropriate filter.
5. NEVER use grinders.
6. ALWAYS follow tool manufacturers' safety recommendations.
7. ALWAYS wear a properly fitted, approved dust mask, P1 or higher

DUST MASKS AND RESPIRATORS

As a minimum, an AS/NZS1716 P1 respirator must be used when doing any activity that may create dust. For more extensive guidance and options for selecting respirators for workplaces please refer to Australian/New Zealand Standard 1715:2009 "Selection, Use and Maintenance of Respiratory Protective Equipment". P1 respirators should be used in conjunction with the above cutting practices to minimise dust exposure. For further information, refer to Safety Data Sheet (SDS) available at www.jameshardie.com.au. If concern still exists about exposure levels or you do not comply with the above practices, you should always consult a qualified industrial hygienist or contact James Hardie for further information.

STORAGE AND HANDLING

To avoid damage, all James Hardie™ building products should be stored with edges and corners of the product protected from chipping. James Hardie™ building products must be installed in a dry state and protected from weather during transport and storage. The product must be laid flat under cover on a smooth level surface clear of the ground to avoid exposure to water, moisture, etc.

SCOPE

General

This guide covers the use of Scyon™ Stria™ cladding in a residential facade application over a seasoned timber wall frame or a light-gauge steel frame.

DESIGN

Compliance

All design and construction must comply with the appropriate requirements of the current National Construction Code (NCC), regulations and standards.

Responsibility

The specifier or other party responsible for the project must ensure that the details in this specification are appropriate for the intended application and that additional detailing is performed for specific design of any areas that fall outside the scope of this specification.

Slab and Footings

The slab and footings on which the building is situated must comply with AS 2870 'Residential slabs and footings – Construction' and the requirements of the National Construction Code (NCC).

Ground Clearances

Install James Hardie™ external cladding with a minimum 150mm clearance to the earth on the exterior of the building or in accordance with local building codes if greater than 150mm is required. Maintain a minimum 50mm clearance between James Hardie™ external cladding and roofs, decks, paths, steps and driveways.

Adjacent finished grade must slope away from the building in accordance with local building codes, typically a minimum slope of 50mm minimum over the first metre.

Do not install external cladding such that it may remain in contact with standing water.

NOTE

Greater clearance may be required in order to comply with termite protection provisions, see below.

Termite Protection

The NCC specifies the requirements for termite barriers. All of these requirements must be satisfied. Where the exposed slab edge is used as part of the termite barrier system, a minimum of 75mm of the exposed slab edge must be visible to permit ready detection of termite entry.

Moisture Management

It is the responsibility of designer or specifier to identify moisture related risks associated with any particular building design. Wall construction design must effectively manage moisture, accounting for both the interior and exterior environments of the building, particularly in buildings that have a higher risk of wind driven rain penetration or that are artificially heated or cooled.

In addition, all wall openings, penetrations, junctions, connections, window sills, heads and jambs must incorporate appropriate flashing and waterproofing. Materials, components and their installation that are used to manage moisture in framed wall

construction must, at a minimum, comply with the requirements of relevant standards and the NCC. For more information in relation to designing for weather tightness, refer to the Building Research Association of New Zealand (BRANZ), www.branz.co.nz

Fire Rated Walls

Fire rated walls can be created with Scyon™ Stria™ cladding and other additional linings to achieve a 60/60/60 and 90/90/90 fire rating when constructed as specified in the James Hardie™ Fire and Acoustically Rated Walls Design Manual. Longer fasteners for fixing the cladding to the wall studs are required to account for the additional linings in a fire rated wall.

FRAMING

General

Scyon™ Stria™ cladding is installed to timber or steel framed structures. Refer to Tables 1 and 2 for maximum stud spacings for Scyon™ Stria™ cladding for Australian wind load classification of AS 4055 'Wind loads for Housing'.

Ensure framing joints are tight and all framing is fully loaded before the Scyon™ Stria™ Cladding is installed

Special framing requirements

The following are special framing requirements for timber framing:

- Additional framing may be required at internal corners and sides of openings, see relevant details on the following pages.
- Extra framing may be necessary for fixing of head flashing and trim. Lintels must be located in the frame flush externally to adequately support the head flashing.

At vertical joints where the flashing strip is used, provide either:

- Double 45mm studs or
- Double 35mm studs separated by 15mm packers or
- Triple 35mm studs

Everywhere else, minimum single 35mm studs unless shown otherwise.

TIMBER

Use of timber framing must be in accordance with AS 1684 - 'Residential timber-framed construction' and the framing manufacturer's specifications.

Use only seasoned timber. Unseasoned timber must not be used because it is prone to shrinkage and can cause sheets and frames to move.

'Timber used for house construction must have the level of durability appropriate for the relevant climate and expected service life and conditions including exposure to insect attacks or to moisture, which could cause decay.' Reference AS 1684.2 'Residential timber-framed construction'.

STEEL

Use of steel framing must be in accordance with NASH standard for Residential and Low-Rise Steel Framing Part 1: Design Criteria and the framing manufactures specifications. Framing members must have a base metal thickness (BMT) between 0.55 to 1.6mm. The steel framing must have the appropriate level of durability required to prevent corrosion.

Thermal Break

For steel frames, it's a building code requirement to install a thermal break behind direct fixed cladding. For information relating to the suitability of James Hardie's HardieBreak™ thermal strip, refer to the HardieBreak™ Installation Guide at www.jameshardie.com.au.

NOTE

When using 70mm deep framing it is recommended that the Scyon™ Stria™ cladding be installed prior to plumbing, electrical and other services within the frame. This will prevent these services being damaged by fasteners used to install Scyon™ Stria™ cladding.

Tolerances

Ensure that the frame is square and work from central datum line. Frames must be straight and true to provide a flush face to receive the Scyon™ Stria™ cladding. A suggested maximum tolerance of between 3 and 4mm in any 3000mm length of frame will give best results. The Scyon™ Stria™ cladding will not straighten excessively warped or distorted frames and any warping may still be visible after product is applied. Non-flat walls will hinder ease of install and full engagement of cladding overlap interlock.

PREPARATION

Weather barrier

A suitable water control membrane must be installed under James Haride™ cladding in accordance with the AS/NZS 4200.2 'Pliable building membranes and underlays – Installation' and NCC requirements.

James Hardie has tested and certified the use of HardieWrap™ weather barrier for climate zones 2-8 within Australia. HardieWrap™ weather barrier is a Class 4 vapour permeable membrane that delivers a triple-shield of protection to help against external weather penetration, internal condensation management and external heat penetration through its safe-glare reflective layer.

If using an alternate product in lieu of HardieWrap™ weather barrier or the project is located in a hot humid area (Climate Zone 1), the designer must ensure that the product is fit for purpose and it has the following classification in accordance with AS/NZS 4200.1:2017 'Pliable building membranes and underlays – Materials':

| CLIMATE ZONES | WATER BARRIER | VAPOUR PERMEANCE |
|---------------|---------------|---------------------------------|
| 2-8 | High | Vapour permeable (Class 3 or 4) |
| 1 | | Vapour Barrier (Class 1 or 2) |

Soft compressible insulation installed between the front of the wall studs and directly behind the external cladding can cause installation issues and is thus not recommended.

Flashing

All wall openings, penetrations, intersections, connections, window sills, heads and jambs must be flashed prior to cladding installation. See 'Moisture management' Section for requirements.

Accessories

Some Scyon™ Stria™ cladding accessories may require installation prior to fixing of the boards. Refer to the relevant details in this document.

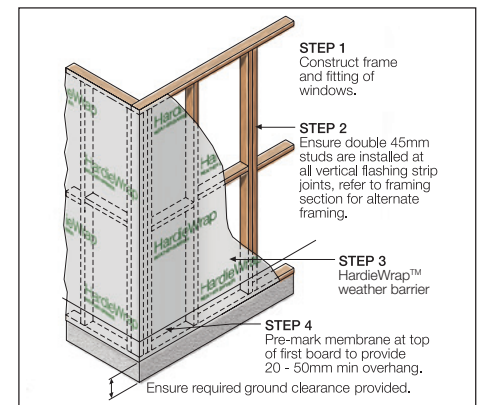

FIGURE 1 PREPARATION

NOTES

1. Ensure all double studs are well nailed together, and flush at the outside face.
2. Generally external and internal corners have additional framing requirements and require that flashings and/or components are fitted prior to fixing the Scyon™ Stria™ cladding. Refer to the external and internal corner details.
3. Before each board is fastened, check that it is level and fully engaged with the lower board.

INSTALLATION

NOTES

1. You must ensure the product is of acceptable quality prior to installation, see Important Note 3.
2. Unless otherwise noted, Scyon™ cladding standard is shown in the following step by step instructions.

Vertical Flashing Stop

At vertical joints, vertical flashing stops are fixed to double 45mm studs, see Figure 2. The rear of the boards are then adhered to the vertical flashing strips using James Hardie™ joint sealant.

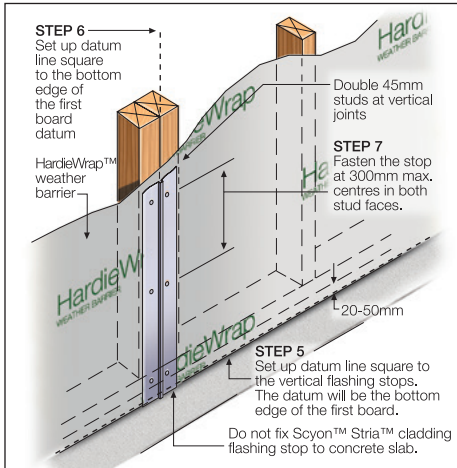

FIGURE 2 INSTALLATION OF FLASHING STRIP

When the boards are ready to be installed, apply James Hardie™ joint sealant to either side of the vertical flashing just prior to installation of each board.

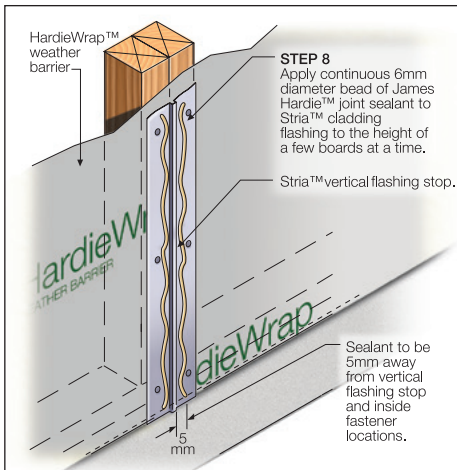

FIGURE 3 APPLY SEALANT TO FLASHING

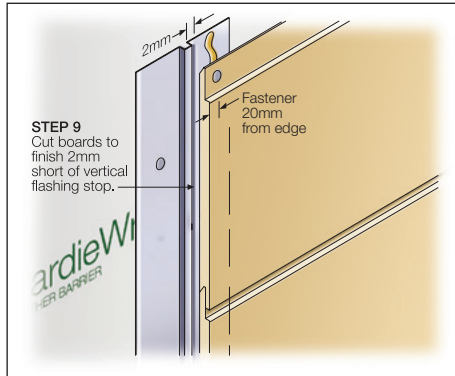

FIGURE 4 BOARD INSTALLATION

Board Installation

NOTES

1. Boards should be nailed to the studs starting from the centre of the board outwards.

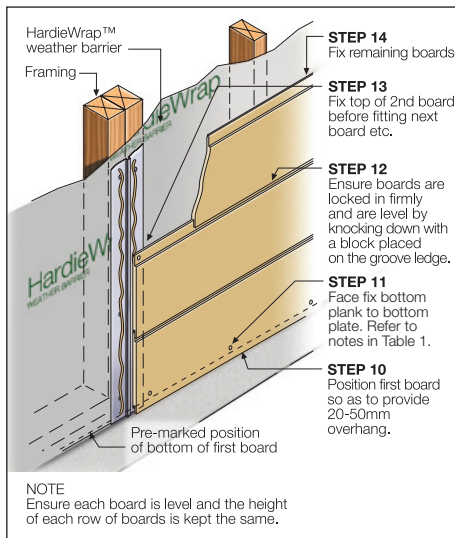

FIGURE 5 BOARD INSTALLATION

NOTE

For the purposes of illustration only, Figure 5 shows concealed fixing method for Scyon™ Stria™ cladding 325mm board. Face fixing for all boards may be required for higher wind load areas, see tables 1 & 2.

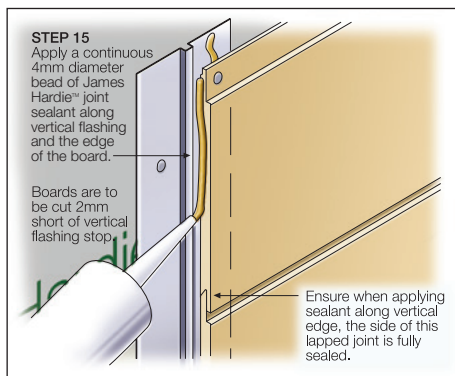

FIGURE 6 SEALING EDGE OF BOARD

Butt Jointing of Boards

If desired Scyon™ Stria™ cladding can be joined on and off stud without the use of the vertical flashing stop to create a traditional butt joint. To maximise strength and good looks, butt joints should be staggered over two or more stud lines (i.e. do not locate joints in the same vertical line).

Ensure the board ends are square and clean.

On Stud Jointing

Fix boards to studs leaving a 3mm gap for sealant.

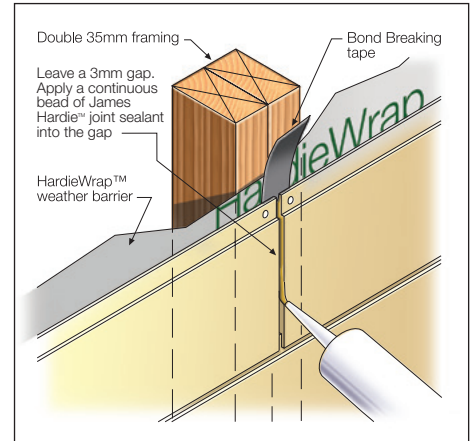

FIGURE 7 ON STUD JOINTING

Off Stud Jointing

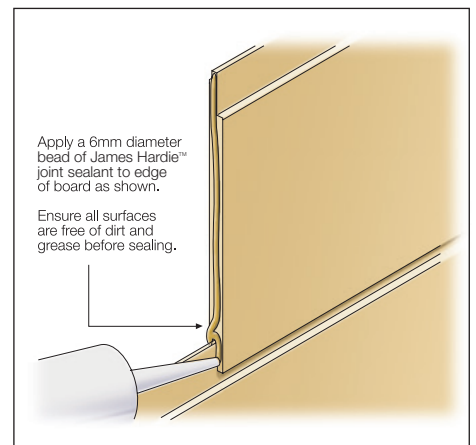

FIGURE 8 SEALING EDGE OF BOARD (STEP 1/2)

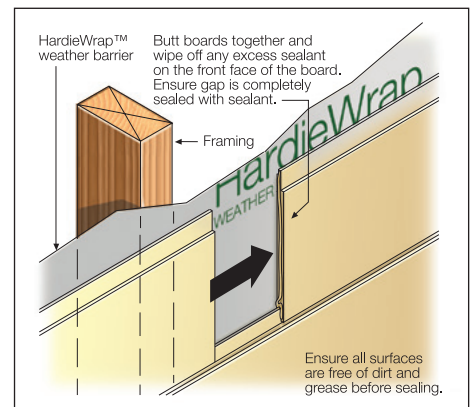

FIGURE 9 OFF STUD JOINTING (STEP 2/2)

Stud Spacing and fixing requirements

NOTE

For steel frames, Tables 1 and 2 are applicable but use appropriate screws as specified under 'Steel frames'.

TABLE 1 - Fixing Options AS 4055 Wind Classification.

| Scyon™ Stria™ cladding standard and splayed Profile. Figures 10A, 10B & 10C | | | | | | |
|---|---------------|---------------------------|-------------------------------------|---------------|------------------------|---------------------------------|
| TIMBER FRAMING | | | | | | |
| Non-Cyclonic Wind | Cyclonic Wind | Fasteners Details | | Fixing Figure | Stud Spacing (mm) | |
| | | | | | General Areas of Walls | Within 1200mm of building edges |
| Concealed Fixing Option | | | | | | |
| N1, N2, N3 | C1 | 40mm FC Nail | 1 per board in underlap HAND NAILED | 10A | 600 | 600 450 (For steel frame) |
| Face Fixing Options | | | | | | |
| N1, N2, N3 | C1 | 50mm Brad Nail (ND or DA) | 2 per board-through face | 10B | 600 | 600 |
| N1, N2, N3 | C1 | 50mm Gun Nail | 1 per board-through face | 10C | 600 | 600 |
| N4 | C2 | 50mm Gun Nail | 1 per board-through face | 10C | 600 | 450 |
| N5, N6 | C3, C4 | 50mm Gun Nail | 2 per board-through face | 10C | 450 | 300 |

TABLE 2 - Fixing Options AS 4055 Wind Classification

| Scyon™ Stria™ cladding wide profile. Figures 10B, 10C & 10D | | | | | | |
|---|---------------|---|---|---------------|------------------------|---------------------------------|
| TIMBER FRAMING | | | | | | |
| Non-Cyclonic Wind | Cyclonic Wind | Fasteners Details | | Fixing Figure | Stud Spacing (mm) | |
| | | | | | General Areas of Walls | Within 1200mm of building edges |
| Face Fixing Options | | | | | | |
| N1, N2, N3 | C1 | 50mm Brad Nail (ND or DA) | 2 per board-through face | 10B | 600 | 600 |
| N1, N2, N3 | C1 | 40mm FC Nail + (50mm Brad ND or DA Nail or 50mm Gun Nail) | 2 per board -1 in underlap, (Hand nailed) and 1 through face (Gun nail) | 10D | 600 | 600 |
| N4 | C2 | 50mm Gun Nail + 40mm FC Nail | 2 per board -1 in underlap, (Hand nailed) and 1 through face (Gun nail) | 10D | 600 | 450 |
| N5, N6 | C3, C4 | 50mm Gun Nail | 3 per board-through face | 10C | 450 | 300 |

NOTES

FIXING TOP AND BOTTOM ROWS OF BOARDS

- For N1, N2, N3 & C1 Bottom and top boards must be fixed with brad nails at 150mm centres or 300mm centres for other fixings.
- For N4, N5, N6, C3 & C4 top and bottom board must be fixed at 150mm centres.
- Fixing at every stud. Unless otherwise stated all values are for timber & steel.

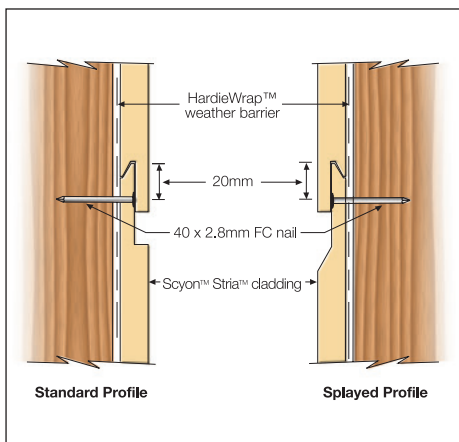

FIGURE 10A CONCEALED FIXING FOR STANDARD AND SPLOYED PROFILES

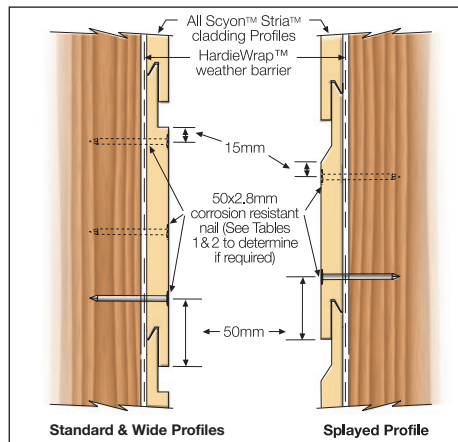

FIGURE 10C FACE FIXING GUN NAILS: FOR ALL 3 SCYON STRIA CLADDING PROFILES

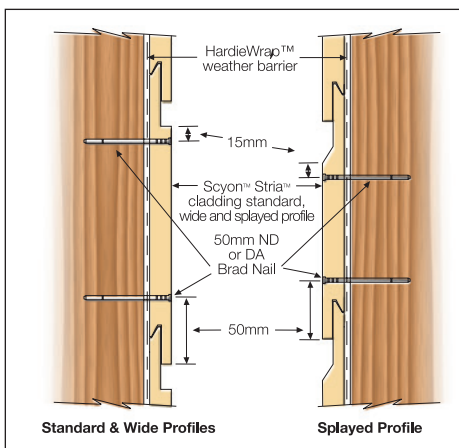

FIGURE 10B FACE FIXING BRAD NAILS: FOR ALL 3 SCYON STRIA CLADDING PROFILES

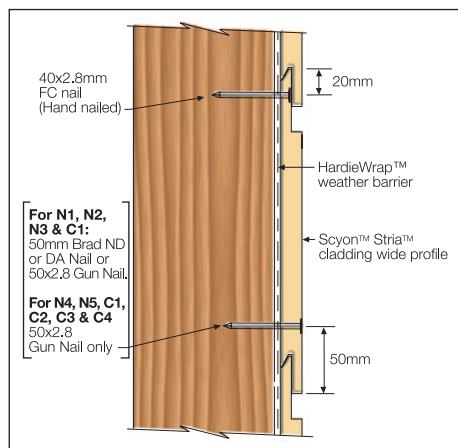

FIGURE 10D FACE/CONCEALED FIXING FOR WIDE PROFILE

FIXING

Scyon™ Stria™ cladding can be fixed by either concealed or face fixing methods depending on the fastener type and wind classification of the building.

NOTE Hold the board hard to the stud when fixing.

FASTENERS

The minimum edge distance to the end of the board is 20mm. All fasteners should be driven flush as shown below.

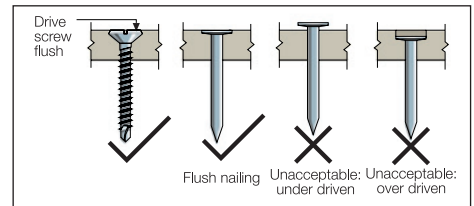

FIGURE 11 FASTENER DEPTH

Fastener Durability

Fasteners must have the appropriate level of durability required for the intended project. This is of particular importance in coastal areas, areas subject to salt spray and other corrosive environments.

Fasteners must be fully compatible with all other materials that they are in contact with to ensure the durability and integrity of the assembly. Contact fastener manufacturers for more information.

Timber Frames

Hand nailing

For fixing through the lap, use 2.8 X 40mm minimum Class 3 fibre cement nails on the underlap in accordance with table 1 and 2 for wind classifications N1, N2 & N3 only.

For face fixing, use 2.8 x 50mm minimum Class 3 fibre cement nails in accordance with tables 1 and 2.

Gun nailing

Gun nailing is only suitable for face fixing and not for fixing through board lap. A minimum class 3 50mm long coil nail or a 50mm Deckfast type D head 2.5mm dia fastener may be used for face fixing only.

If using nail guns refer to fixing options table for nailing configuration. Underlap nail is placed 20mm down from top on tongue.

Face nails are placed 50mm up from the bottom edge. If a second face nail is required it is placed 15mm down from the face ledge. See Figure 10C.

Adjust nail gun to set nail proud of surface, then carefully flush fix with a hammer by hand.

Do not overdrive the nails.

Steel Frames

For both concealed and face fixing, a minimum class 3. Do not overdrive the screws.

For steel framing thickness of 0.5mm – 1.6mm BMT – use 41mm HardieDrive™ screws.

James Hardie™ HardieBreak™ thermal strip must be installed behind the Scyon™ Stria™ cladding. Refer to the HardieBreak™ Thermal Strip Installation Guide for more information.

EXTERNAL CORNERS

Scyon™ Axent™ trim corner

NOTE: Refer to Scyon™ Axent™ trim Installation Instructions for installation information.

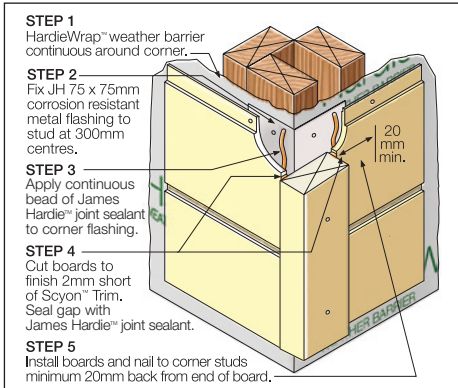

FIGURE 12 EXTERNAL TRIM CORNER - ALL PROFILES

Mitre Corner

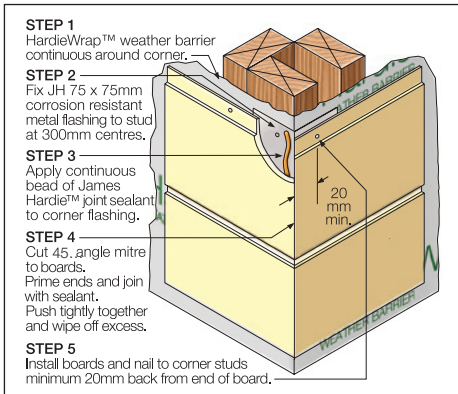

FIGURE 13 EXTERNAL MITRE CORNER - ALL PROFILES

Box Corner

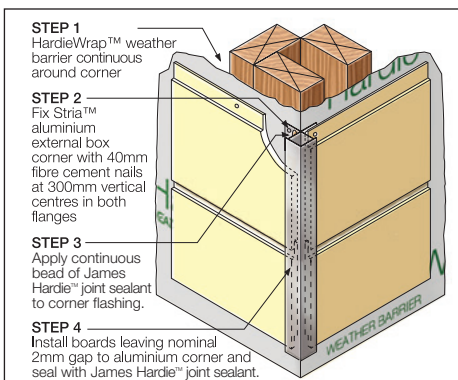

FIGURE 14 STRIA 14MM EXTERNAL BOX CORNER - STANDARD AND WIDE PROFILES

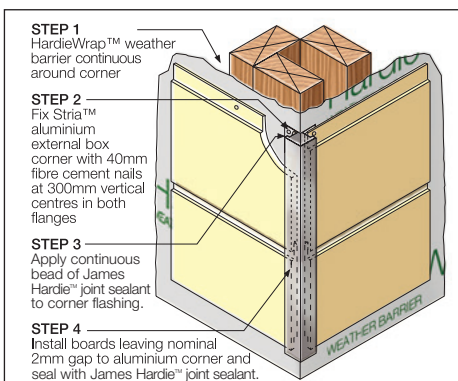

FIGURE 14B JH 16MM ALUMINIUM EXTERNAL TRIM CORNER - SPLAYED PROFILE

INTERNAL CORNERS

Internal Mitre Corner

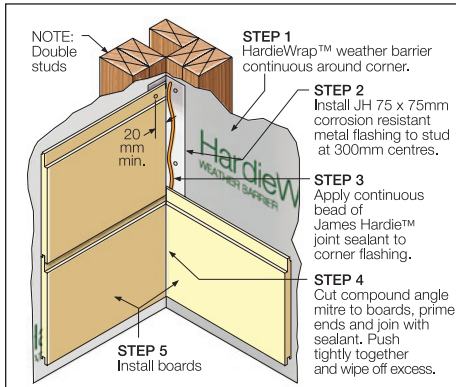

FIGURE 15 INTERNAL MITRE CORNER - ALL PROFILES

Internal Aluminium Corner

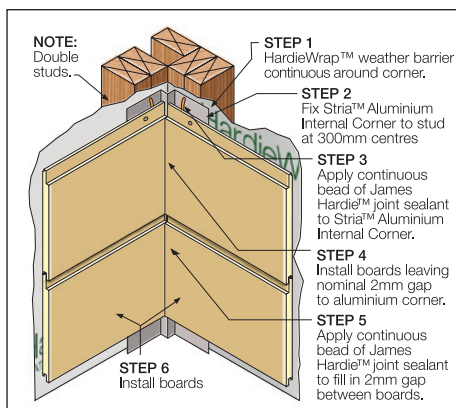

FIGURE 16 ALUMINIUM 14MM CORNER DETAIL - STANDARD AND WIDE PROFILE

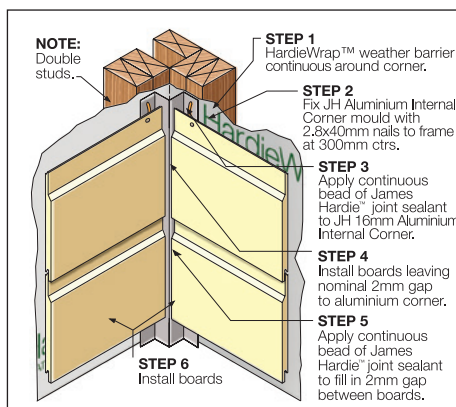

FIGURE 16B ALUMINIUM 16MM CORNER DETAIL - SPLAYED PROFILE

WINDOWS

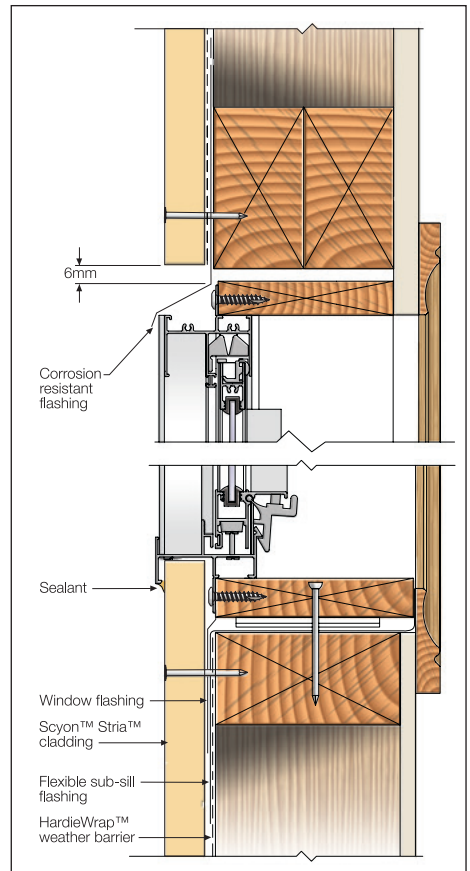

FIGURE 17 WINDOW CROSS SECTION

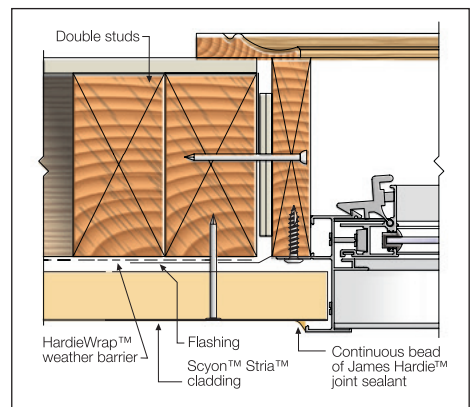

FIGURE 18 WINDOW JAMB DETAIL

SLAB / EAVE JUNCTION

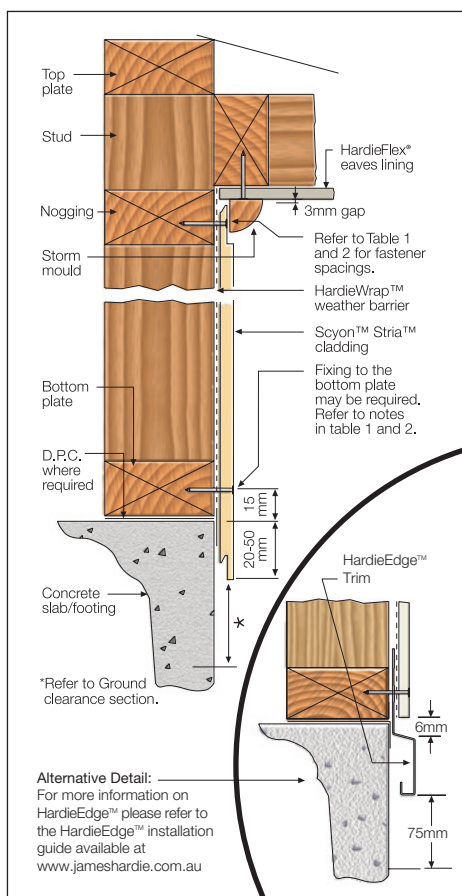

FIGURE 19 SLAB / EAVE DETAIL

FINISHING

Preparation and Priming

Scyon™ Stria™ cladding and Scyon™ Trim™ are pre-primed and must be dry before painting.

Priming of filled and sanded patches may be required in accordance with paint manufacturer's specifications.

NOTE: Care must be taken not to over-sand the boards as it can affect the finish.

Sealants

Application and use of sealants must comply with manufacturer's instructions. Sealants, if coated, must be compatible with the paint system. James Hardie™ recommends the use of James Hardie™ joint sealant, which is a paintable polyurethane sealant.

Painting

Refer to the project specification for paint requirements. The Scyon™ Stria™ cladding and Scyon™ Axent™ trim are pre-primed and must be painted within 3 months of being fixed. James Hardie™ recommends the application of two coats minimum of a quality exterior acrylic paint over the pre-primed boards in accordance with the paint manufacturer's specifications. Some environments require special coatings. Painting selection and specifications are dependant on the paint chosen. Refer to the paint manufacturer for information and details of their warranty.

Staining

James Hardie™ does not recommend stains and clear coats directly applied to its external cladding products. For a stained look solution, contact the James Hardie™ technical team on 13 11 03

MAINTENANCE

The extent and nature of maintenance will depend on the geographical location and exposure of the building. As a guide, it is recommended that basic normal maintenance tasks shall include but not be limited to:

- Washing down exterior surfaces every 6-12 months*
- Re-applying of exterior protective finishes*
- Maintaining the exterior envelope and connections including joints, penetrations, flashings and sealants that may provide a means of moisture entry beyond the exterior cladding.
- Ensuring clearances specified in this document are maintained.
- Cleaning out gutters, blocked pipes and overflows as required.
- Pruning back vegetation that is close to or touching the building.

*Refer to your paint manufacturer for washing down and recoating requirements related to paint performance.

PRODUCT INFORMATION

General

Scyon™ Stria™ cladding and Scyon™ Axent™ trim are made from an advanced material composite technology. The basic composition of James Hardie™ building products is Portland cement, ground sand, cellulose fibre, water and proprietary additives.

James Hardie™ building products are manufactured AS/NZS 2908.2 'Cellulose-Cement Products-Flat Sheet'. These are also compliant with equivalent standard ISO 8336 'Fibre-cement flat sheets - Product specification and test methods'. For product classification refer to the relevant Physical Properties Data Sheet.

For Material Safety Data Sheets (MSDS) visit www.jameshardie.com.au or Ask James Hardie™ on 13 1103.

Durability

Resistance to moisture/rotting

The Scyon™ Stria™ cladding and Scyon™ Axent™ trim has demonstrated resistance to permanent moisture-induced deterioration (rotting) by passing the following tests in accordance with AS/NZS 2908.2:

- Water permeability (Clause 8.2.2)
- Warm water (Clause 8.2.4)
- Heat rain (Clause 6.5)
- Soak dry (Clause 8.2.5).

Resistance to fire

Scyon™ Stria™ cladding is suitable where non-combustible materials are required in accordance with C1.9 of the National Construction Code (NCC).

James Hardie™ building products have been tested by CSIRO in accordance with AS/NZS 3837 and are classified as conforming to Group 1 material (highest and best result possible), with an average specific extinction area far lower than the permissible 250m²/kg, as referenced in Specification C1.10a of the NCC.

Resistance to termite attack

Based on testing completed by CSIRO Division of Forest Products and Ensis Australia James Hardie™ building products have demonstrated resistance to termite attack.

Alpine regions

In regions subject to freeze/thaw conditions, all James Hardie™ fibre cement external cladding must be installed and painted in the warmer months of the year where the temperature does not create freeze and thaw conditions or paint issues. The cladding must be painted immediately after installation. In addition, fibre cement cladding must not be in direct contact with snow and/or ice build up e.g. external walls in alpine regions subject to snow drifts over winter.

Furthermore, a reputable paint manufacturer must be consulted in regards to a suitable product, specifications and warranty. The paint application must not be carried out if the air temperature or the substrate temperature is outside the paint manufacturer's recommendation including the specified drying temperature range.

James Hardie™ external cladding products are tested for resistance to frost in accordance with AS/NZS 2908.2 Clause 8.2.3.

Ask James Hardie™
Call 13 11 03
www.jameshardie.com.au

Notes

Notes



**For information and advice
call 13 11 03 | jameshardie.com.au**

Australia June 2020

© 2020 James Hardie Australia Pty Ltd ABN 12 084 635 558
™ and © denote a trademark or registered mark owned by James Hardie Technology Limited.

